

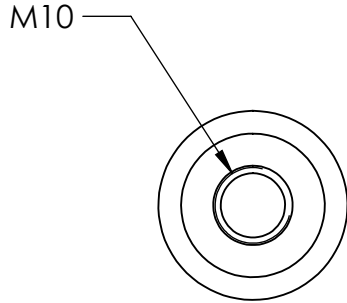

R24,1

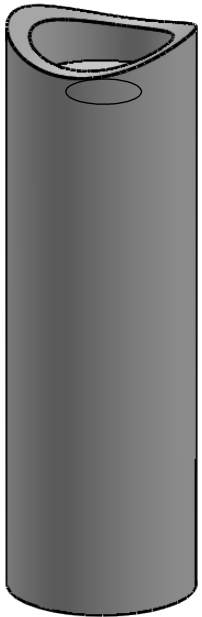
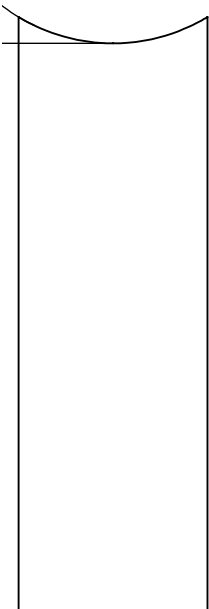
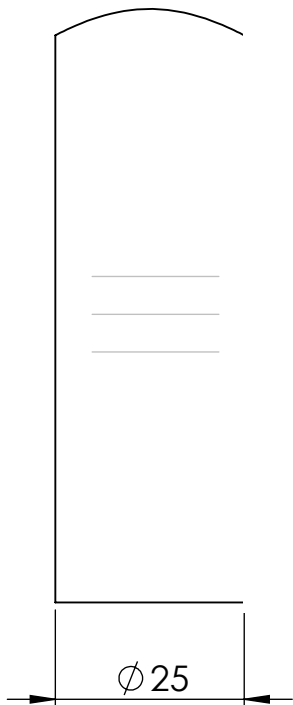
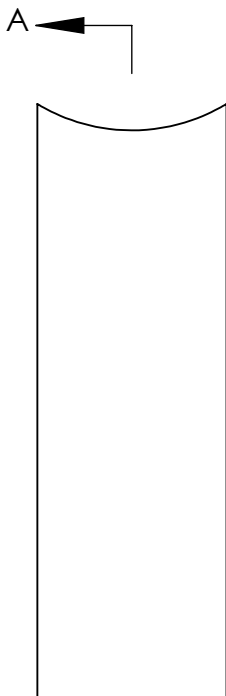
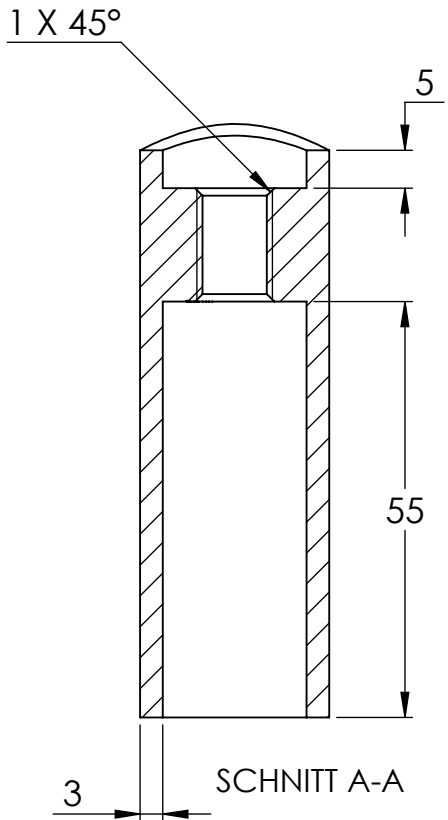

Name	Signatur	Datum	Artikelnummer	Oberfläche: Geschliffen Korn 240
Ch. Höfig	CH	19.09.2023	51410-240-48-75	
Werkstoff: 1.4301 (X5CrNi18-10)			Hersteller	
Gewicht: 0.152 kg			Maßstab: 1:1	Version: 1 Deutsch Blatt 1 von 1
				Blattformat A4