

Tragkraft: 350kg
Gilt für 2 Bänder

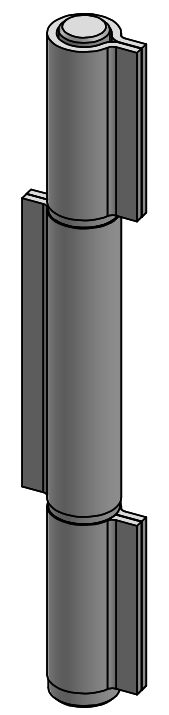

1 X 45°

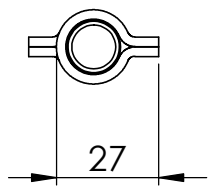
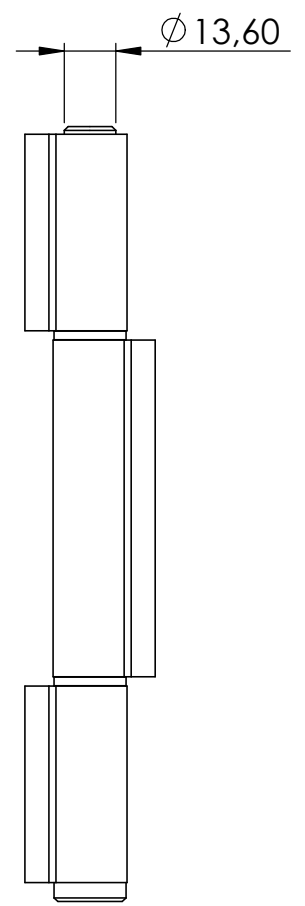
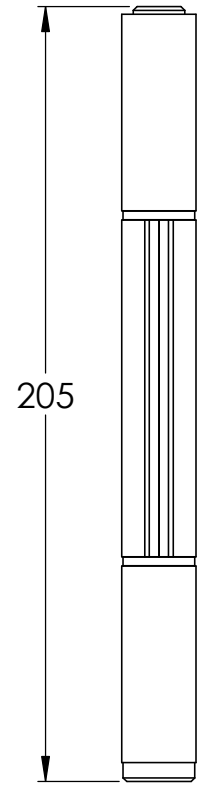
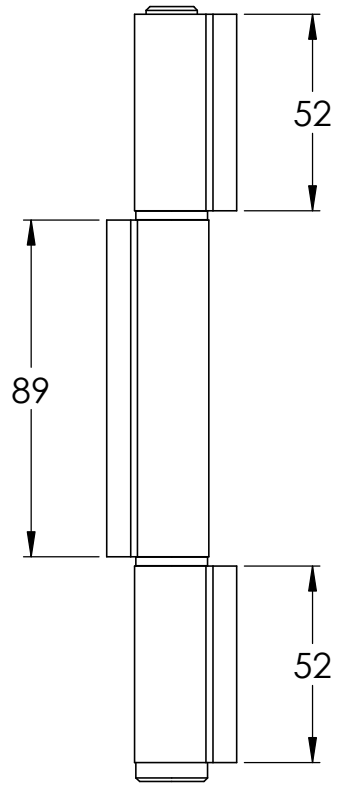
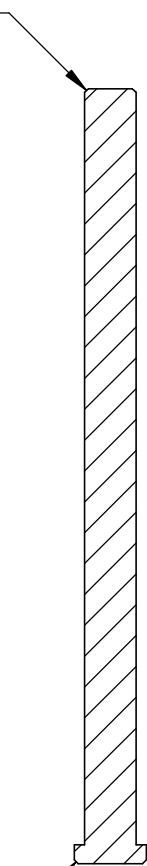

1 X 45°

SCHNITT A-A

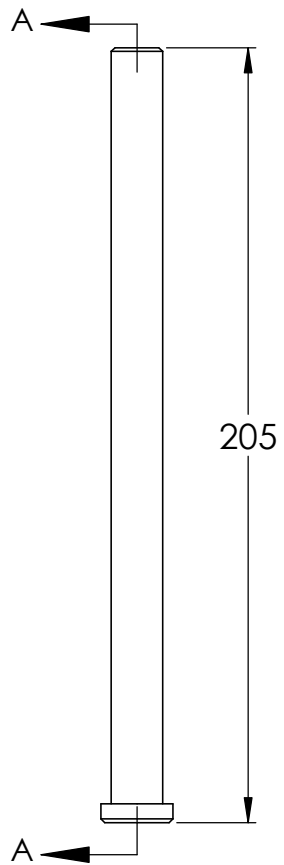
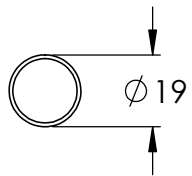

$\phi 13,60$

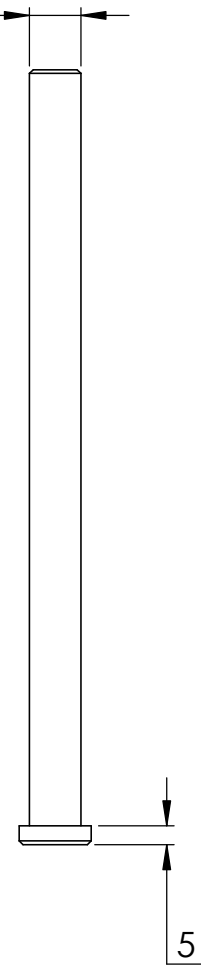

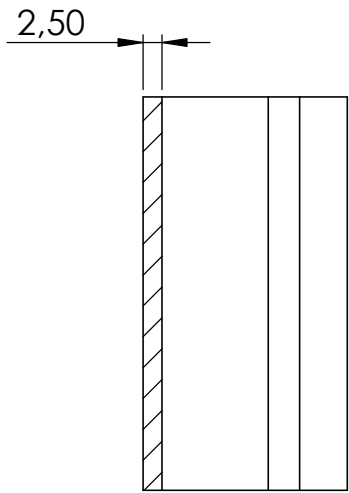
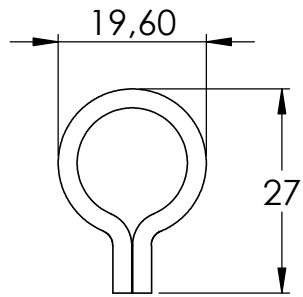

SCHNITT B-B

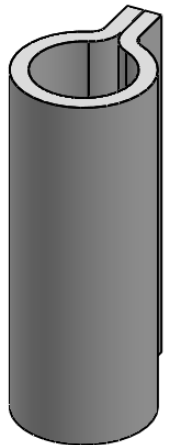
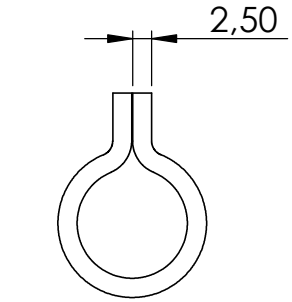
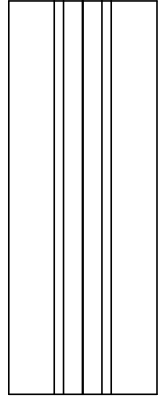
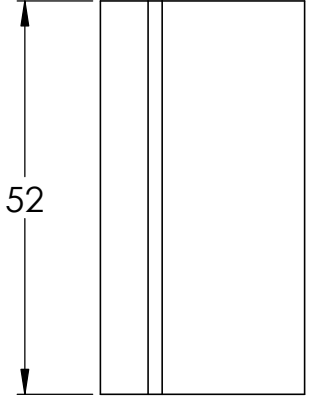
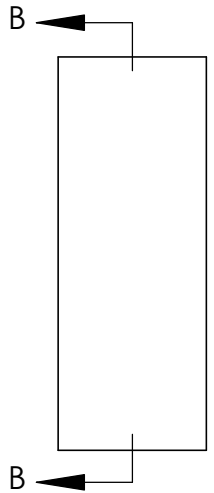

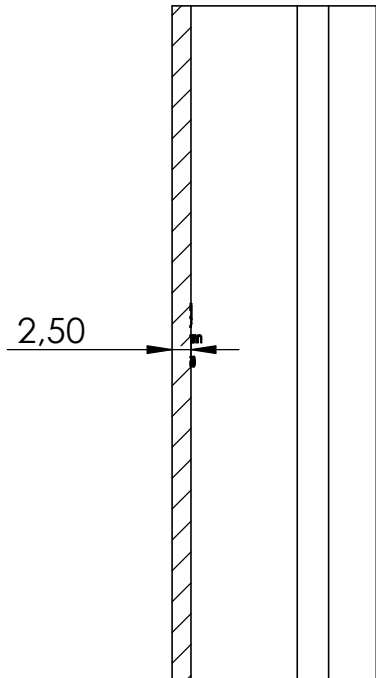
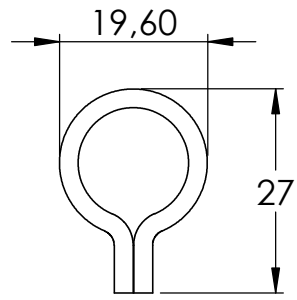

SCHNITT C-C

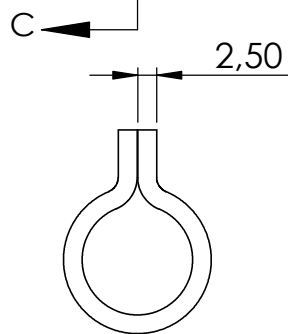
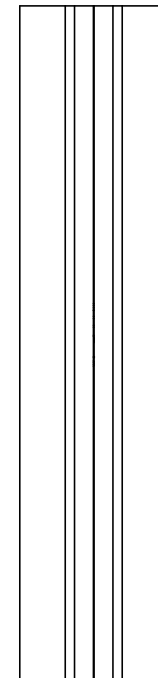
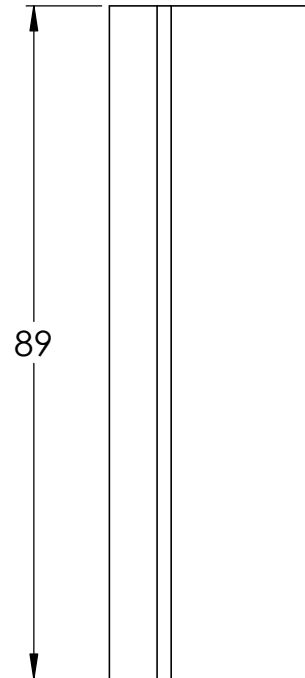
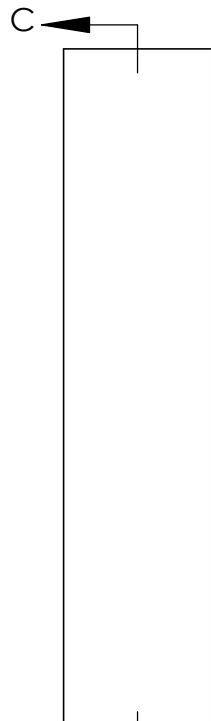

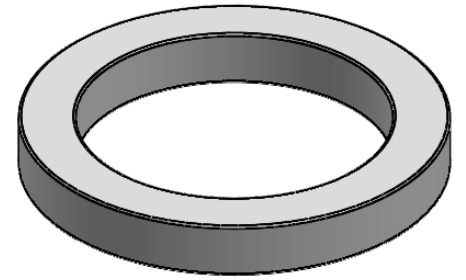
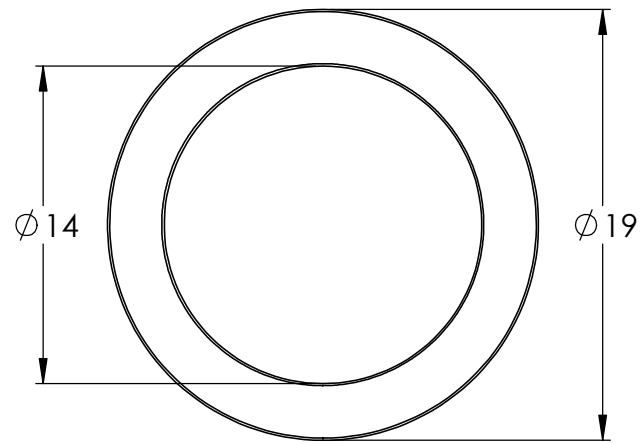

4

415-20 Teil3

1

