

Tragkraft: 250kg  
Gilt für 2 Bänder

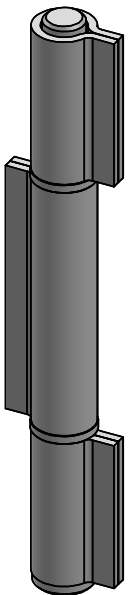

1 X 45°

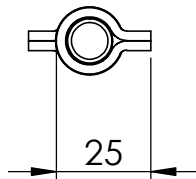
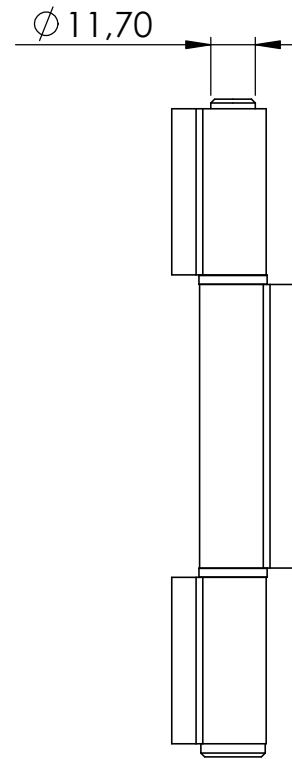
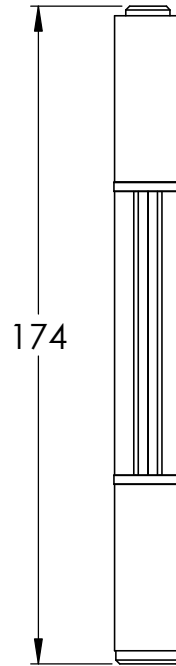
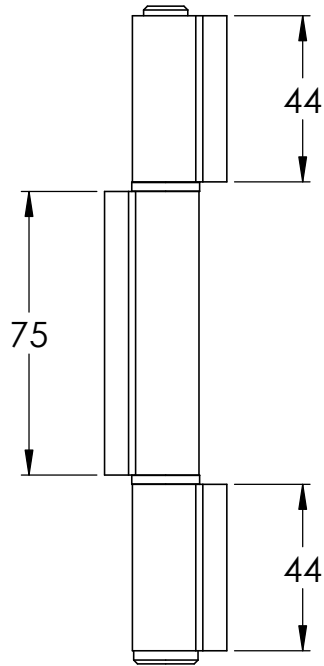
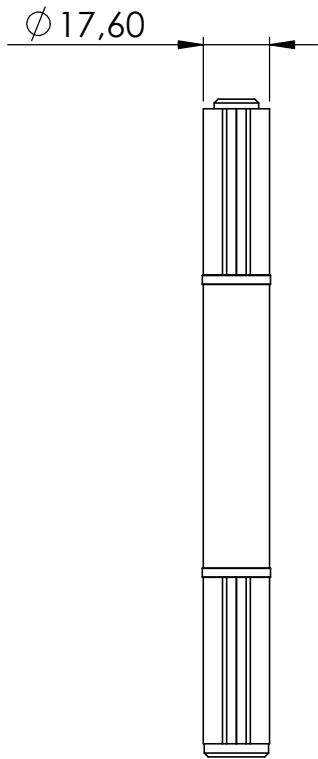
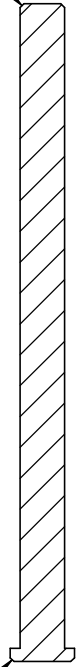

1 X 45°

SCHNITT A-A

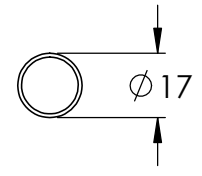

Ø 17

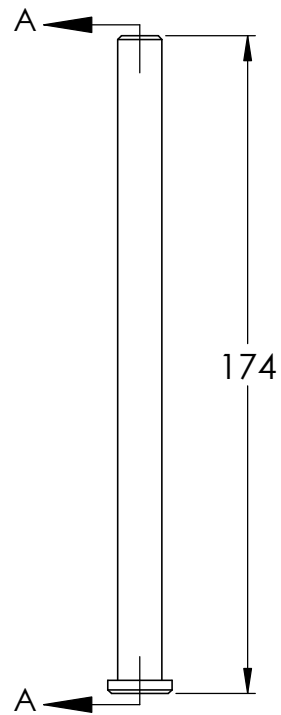

174

Ø 11,70

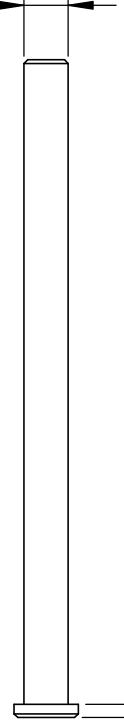

3,50

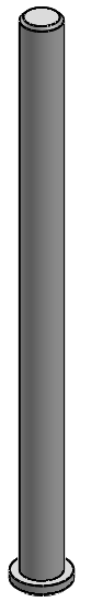

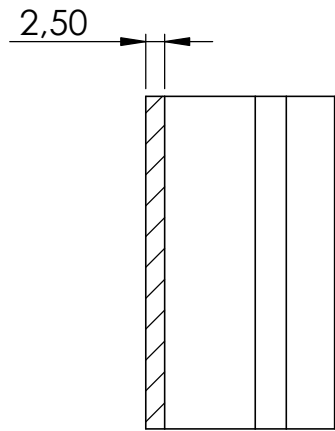
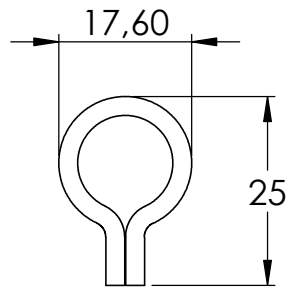

SCHNITT B-B

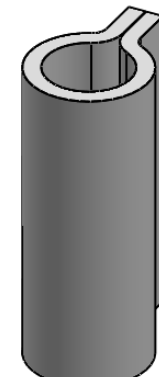
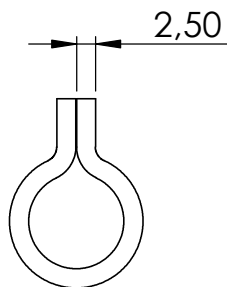
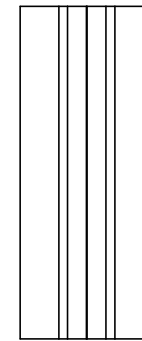
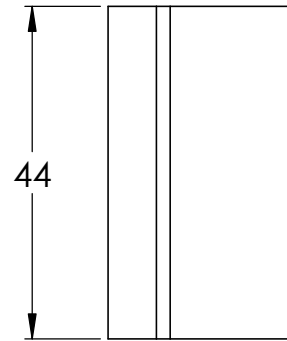
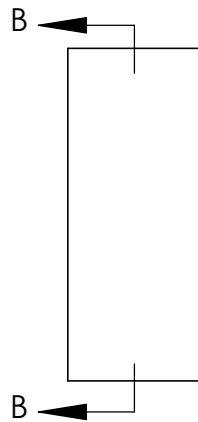

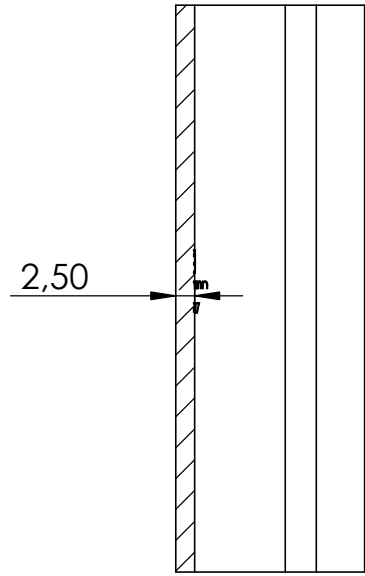
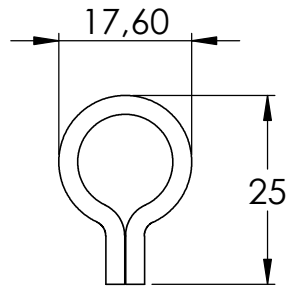

SCHNITT C-C

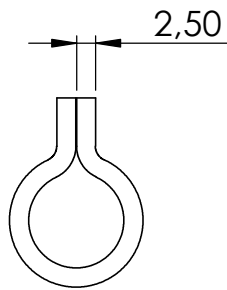
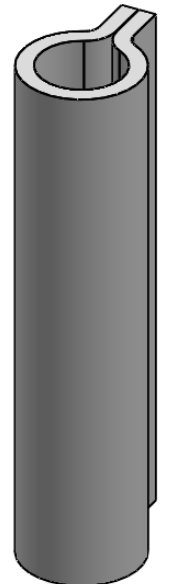
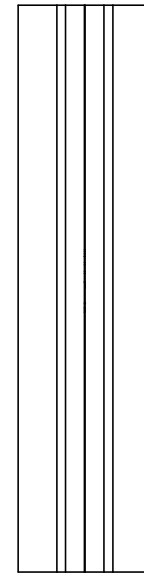
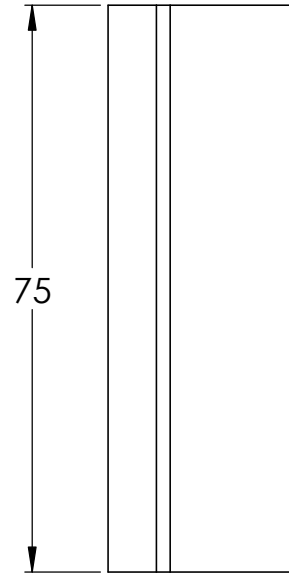
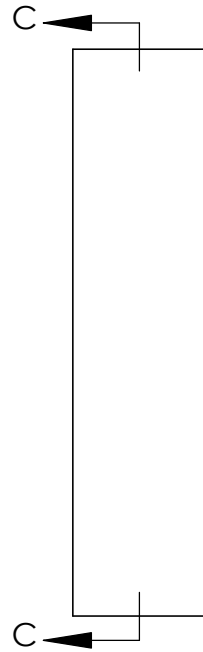

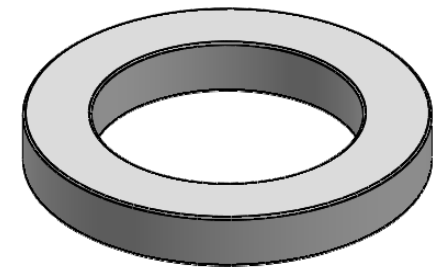
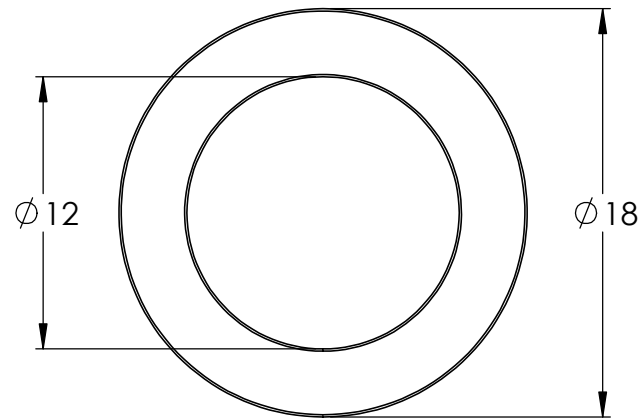

4

415-17 Teil3

1

