

Tragkraft: 150kg
Gilt für 2 Bänder

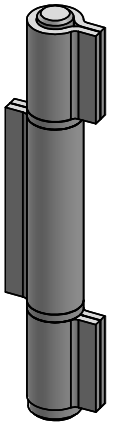

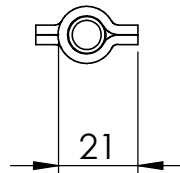

1 X 45°
SCHNITT A-A

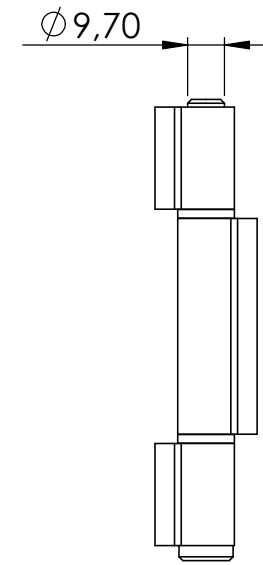
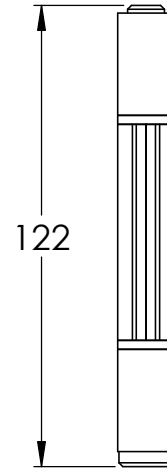
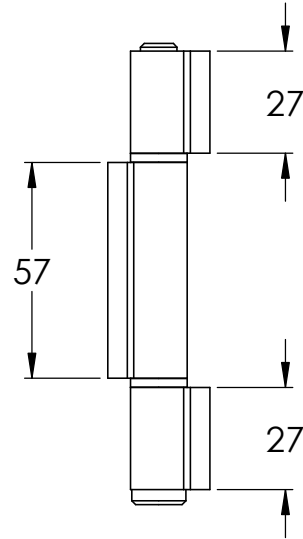
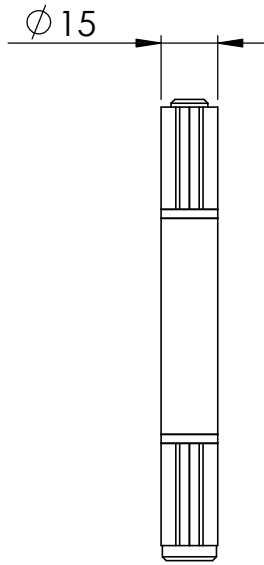
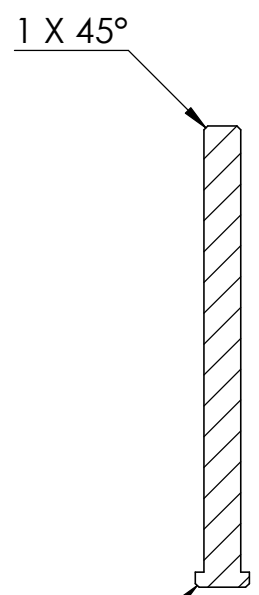
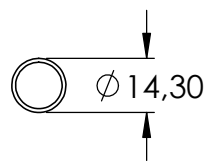

A ←

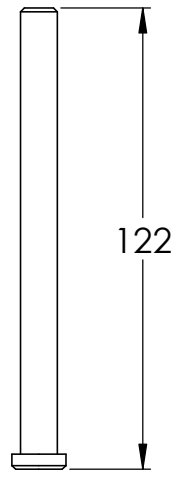

122

A ←



$\phi 9,70$

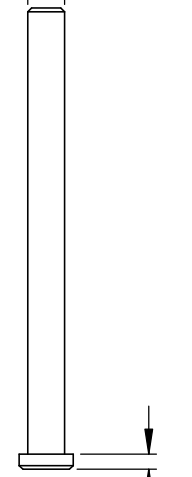

4



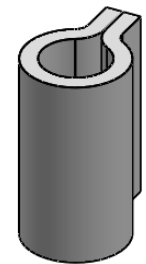
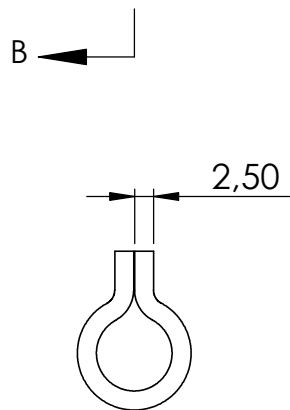
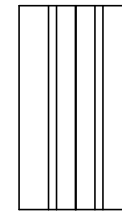
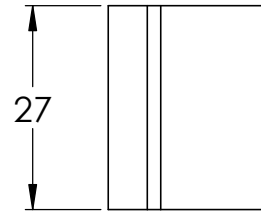
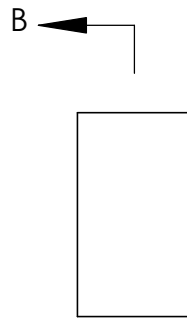
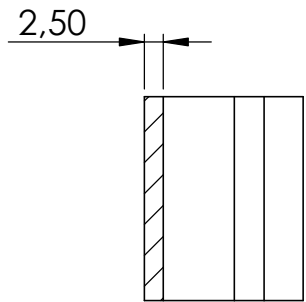
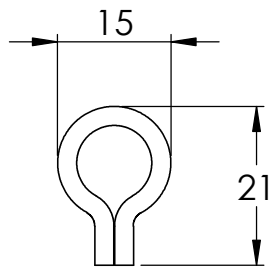

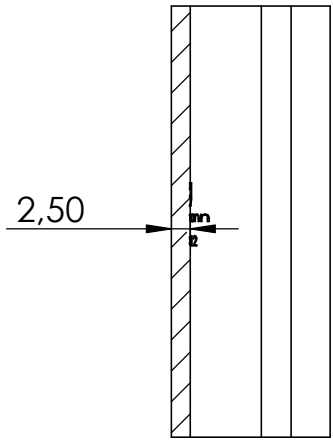
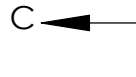
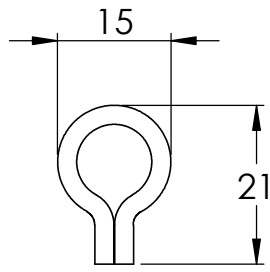

SCHNITT C-C

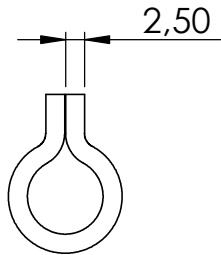
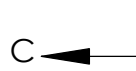
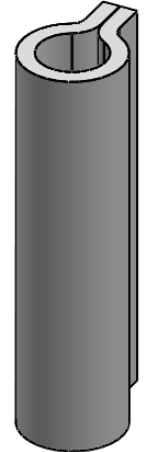
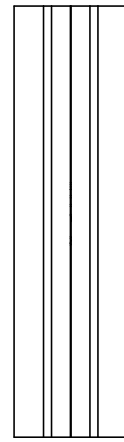
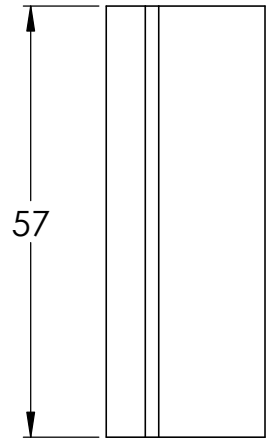
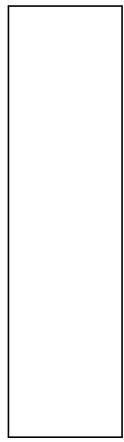

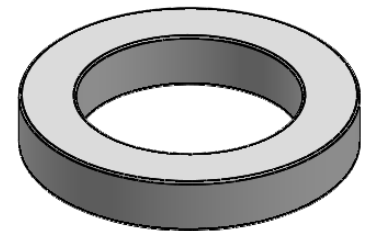
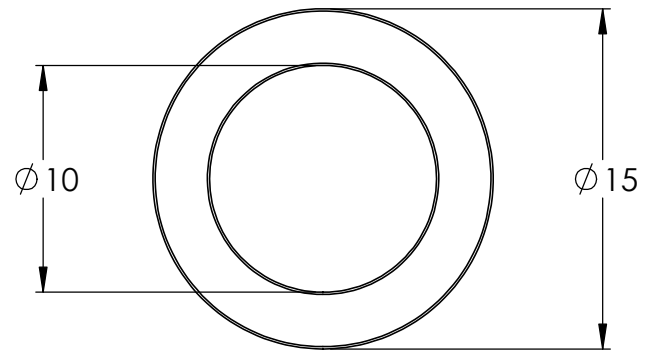
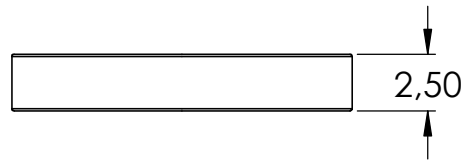

4

410-12 Teil3

1

