

Tragkraft: 300kg  
Gilt für 2 Bänder

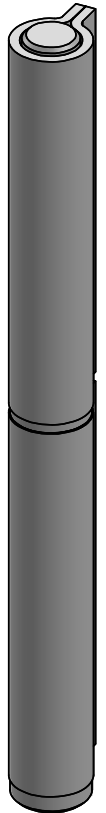

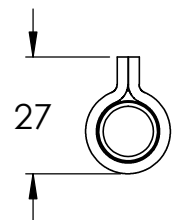

SCHNITT A-A

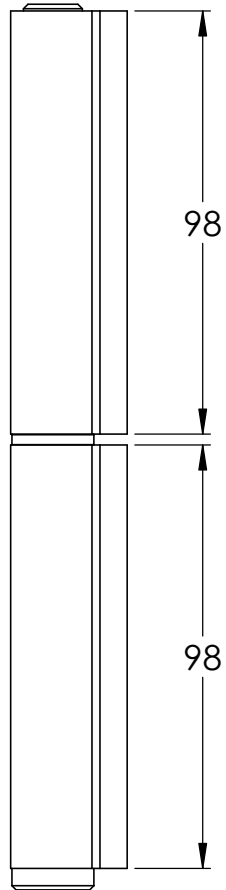
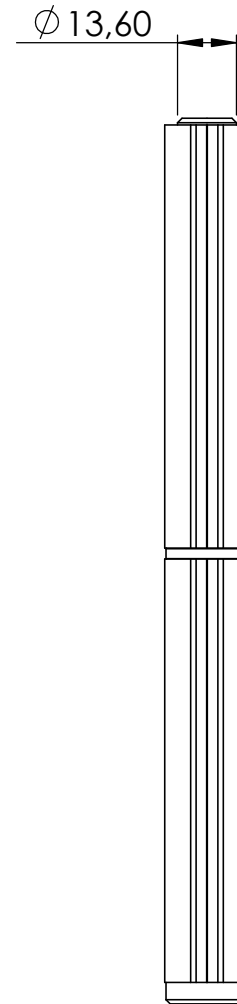
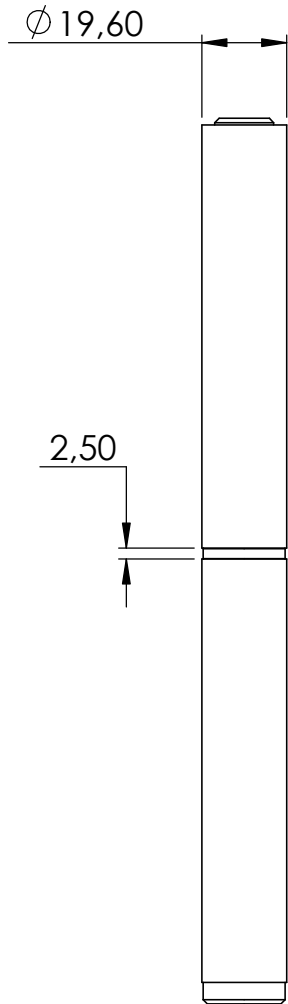
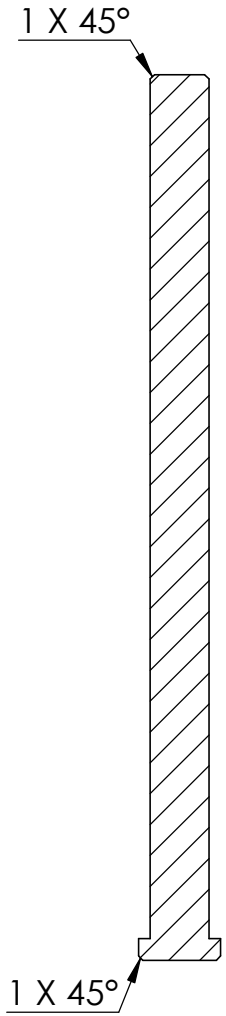
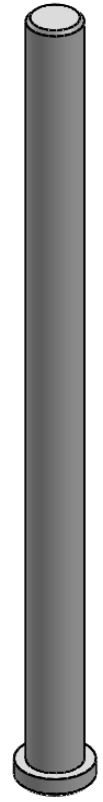
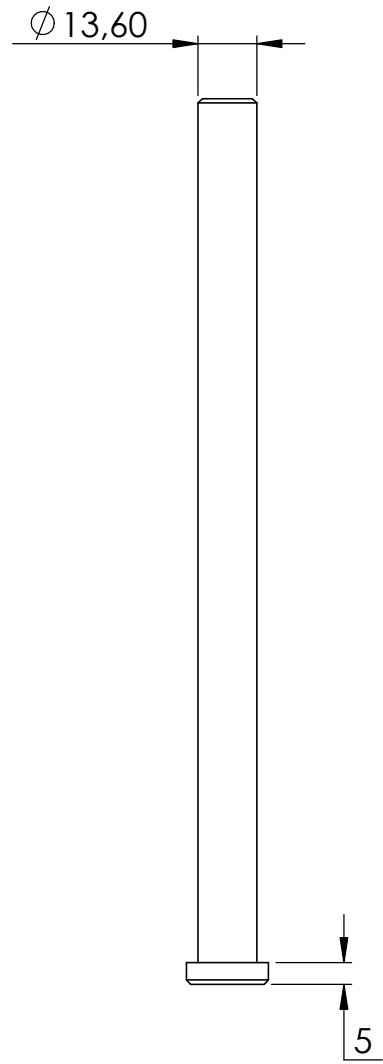
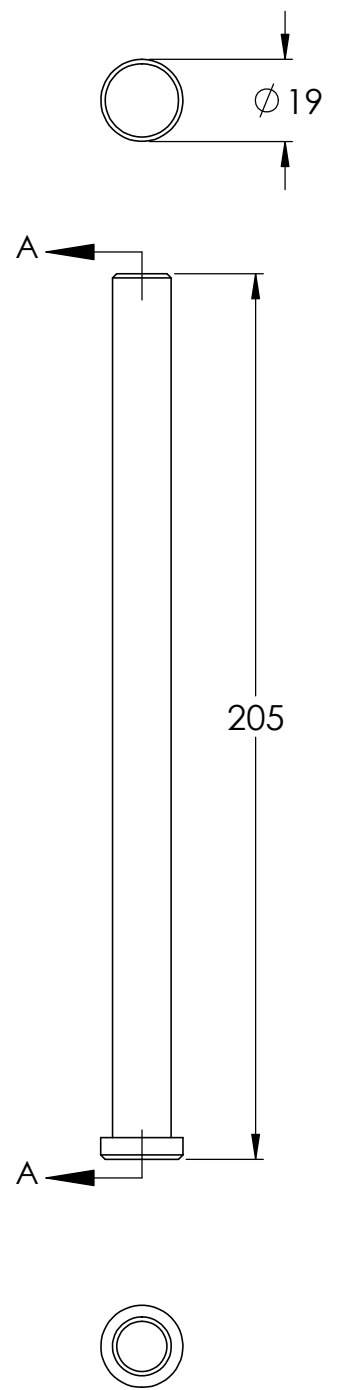

2,50

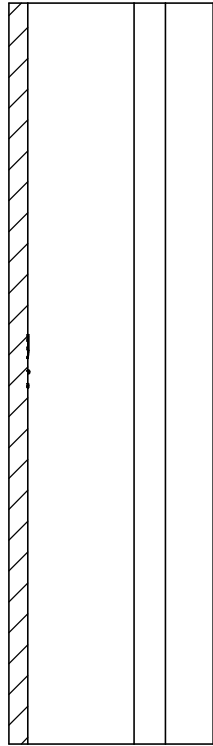

SCHNITT B-B

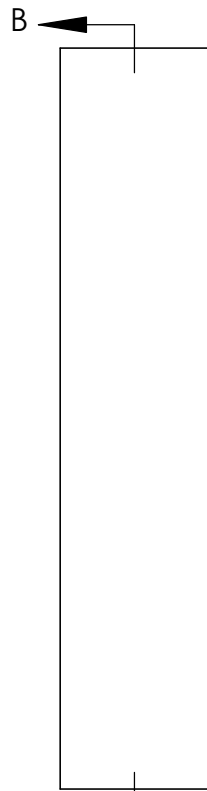
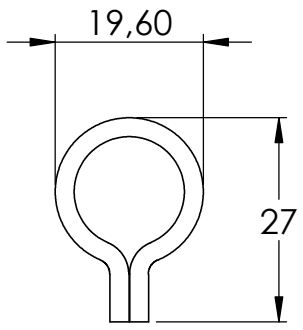

2,50

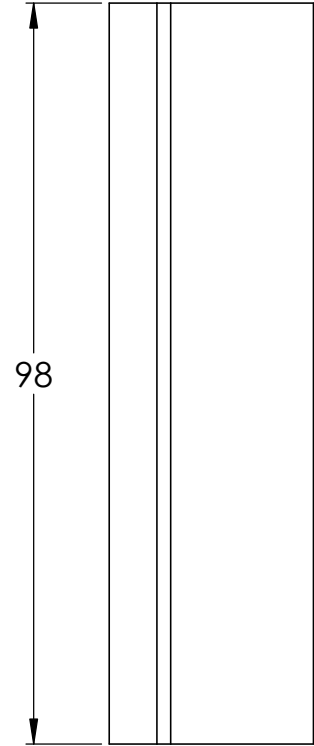
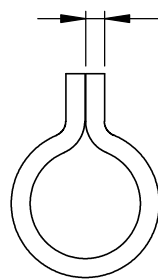

98

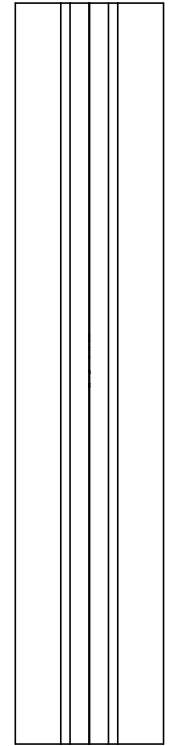

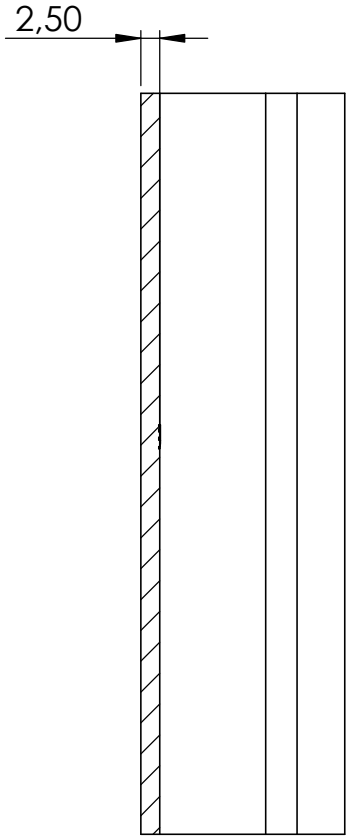
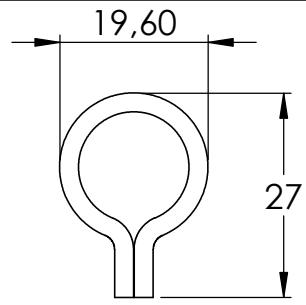

SCHNITT C-C

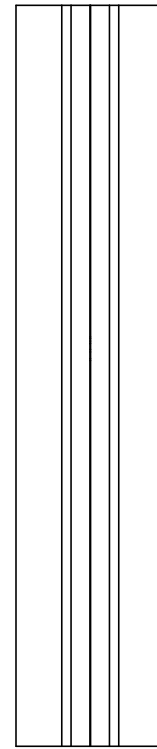
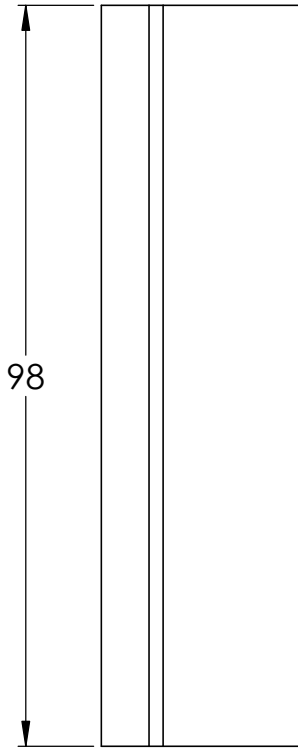
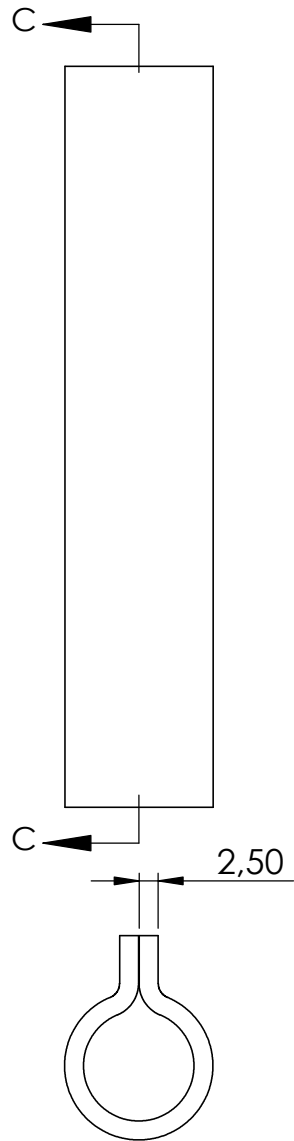

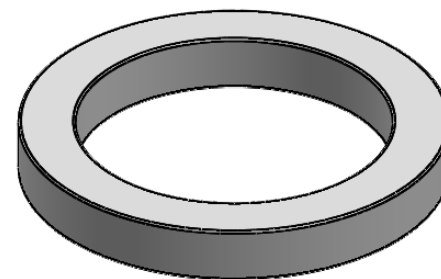
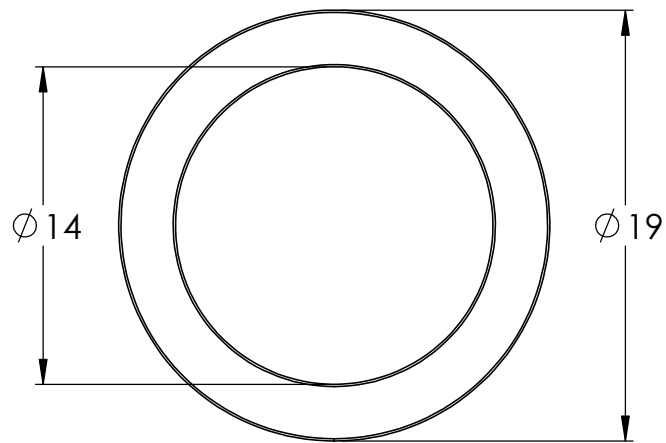

4

405-20 Teil4

1

