

SCHNITT A-A

geöffnet

geschlossen

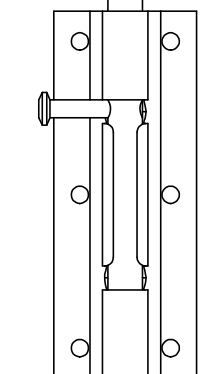
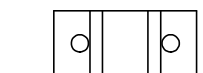
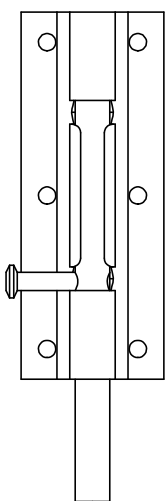

33

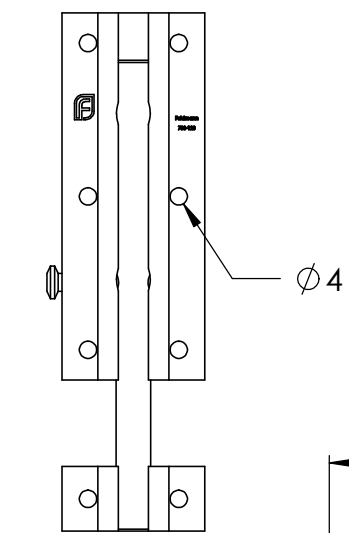

$\phi 4$

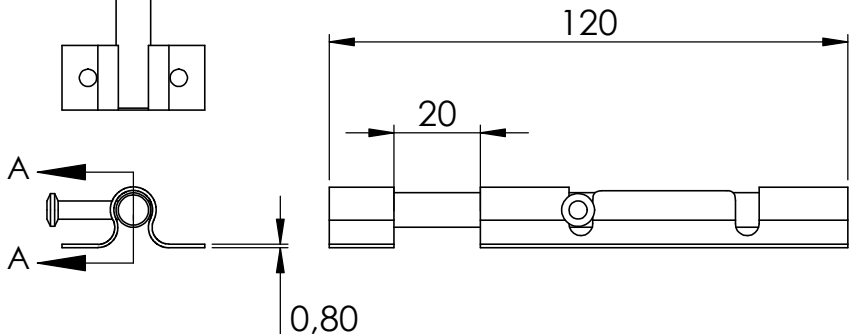

120

20

0,80

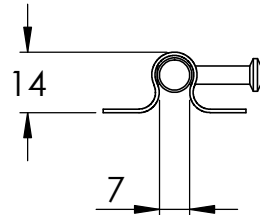

14

7

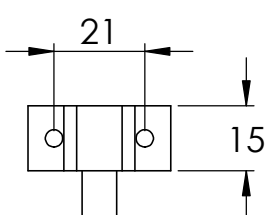

21

15

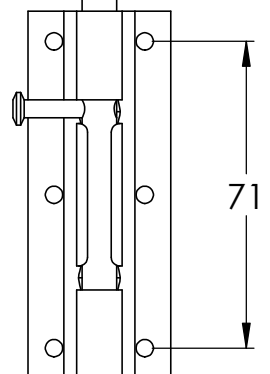

71

