

SCHNITT B-B

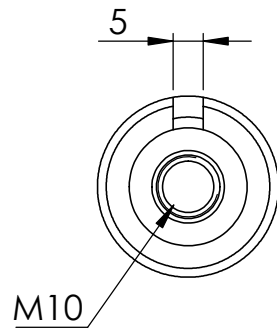

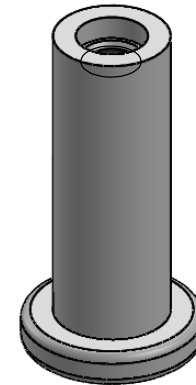

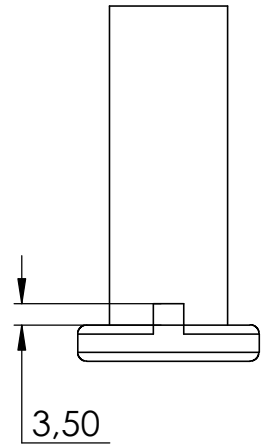

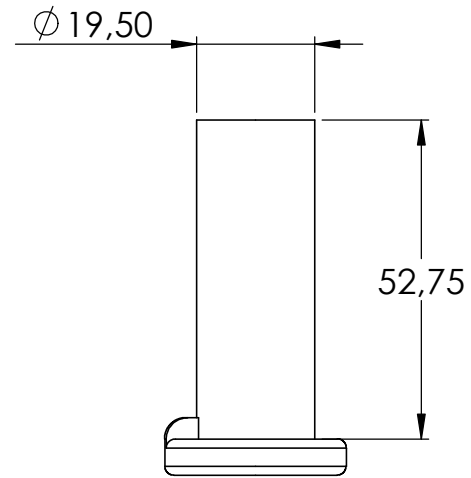
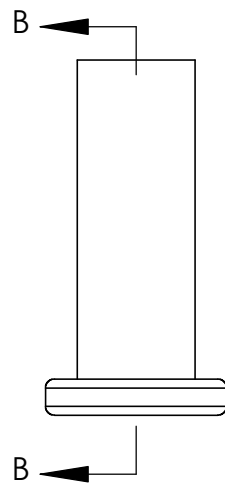
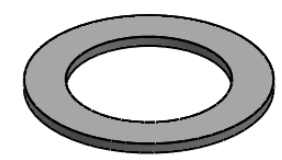
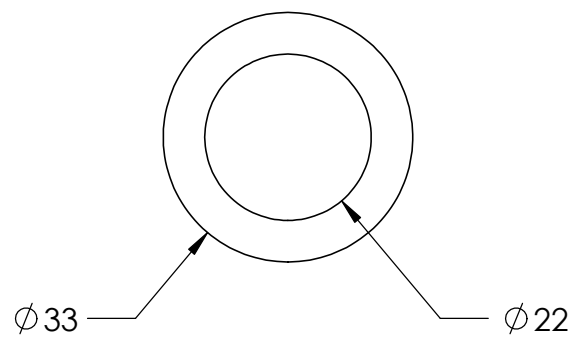
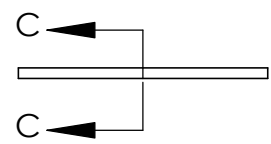
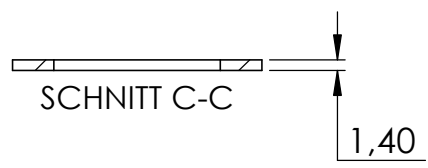
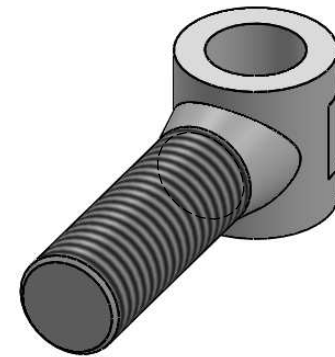
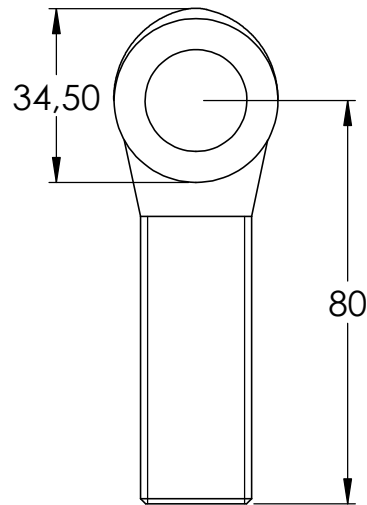
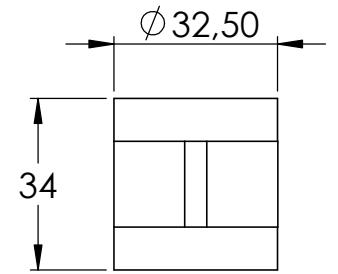
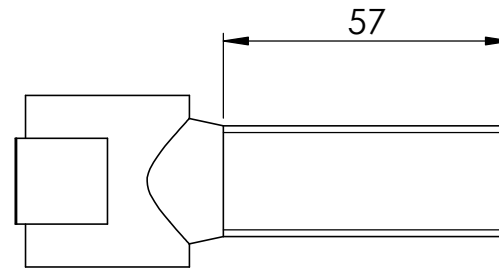
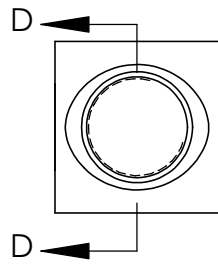
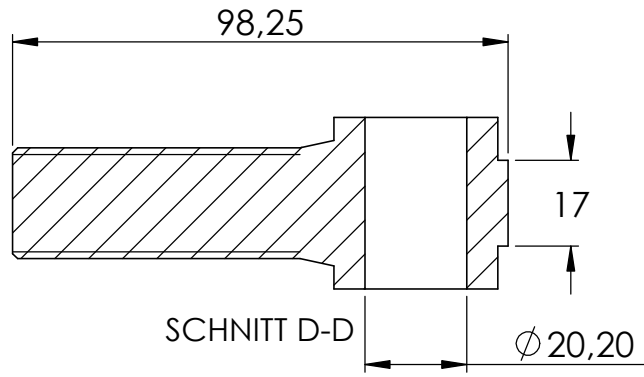
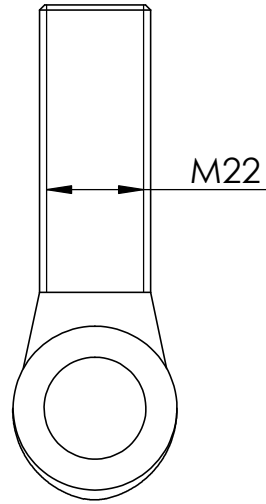
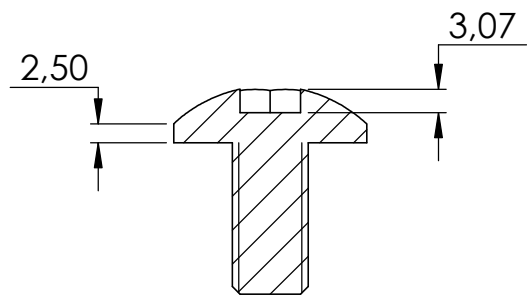

SCHNITT E-E

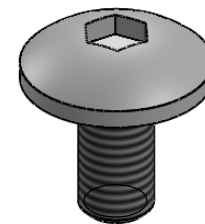
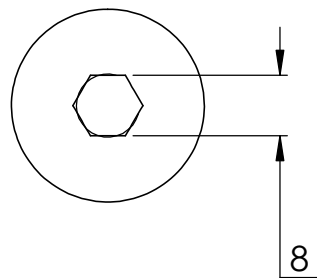
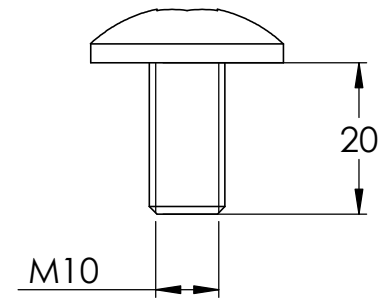
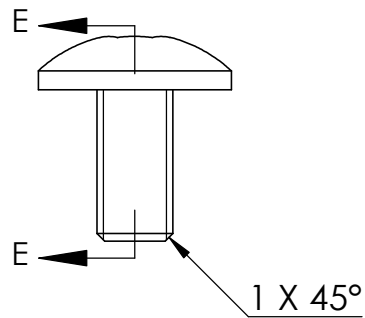
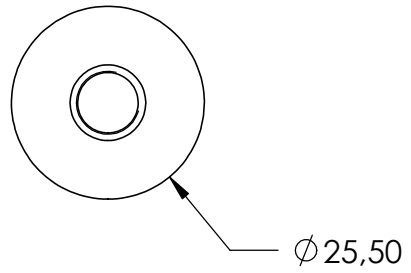

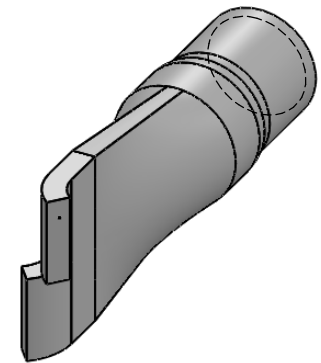
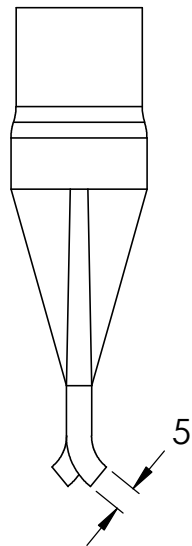
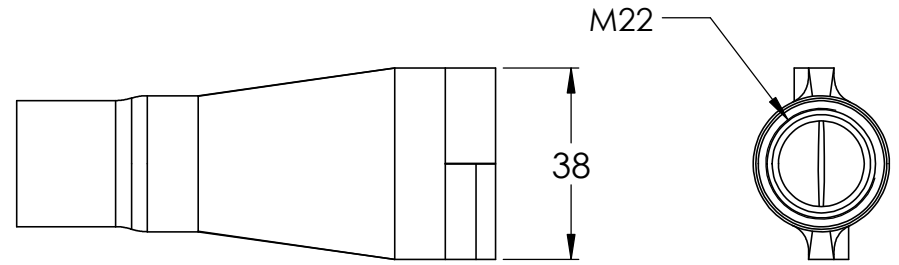
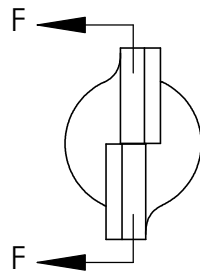
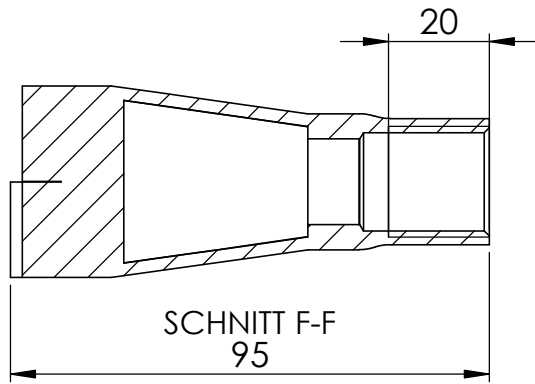
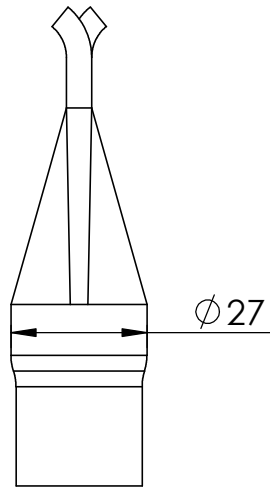

4	140-M22 Teil6	1
5	140-M22 Teil1	2
6	140-M22 Teil2	1

