

SCHNITT A-A

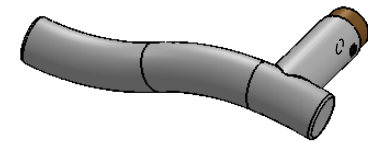

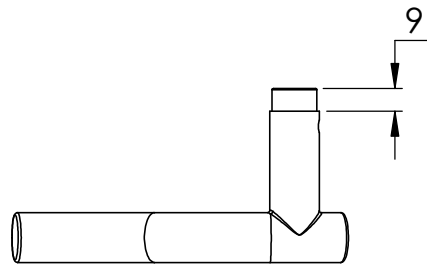

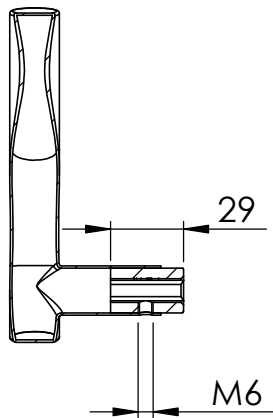
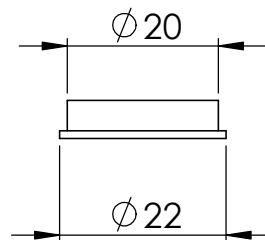
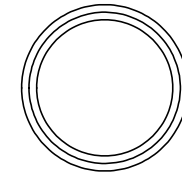
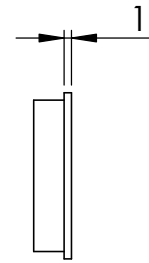
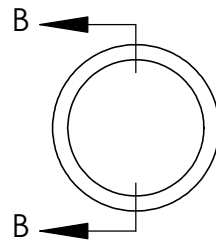
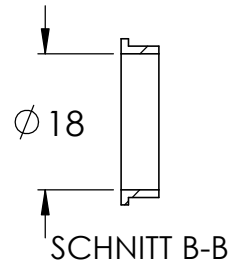
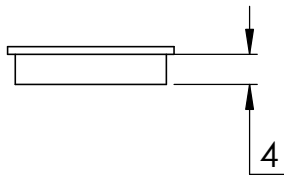
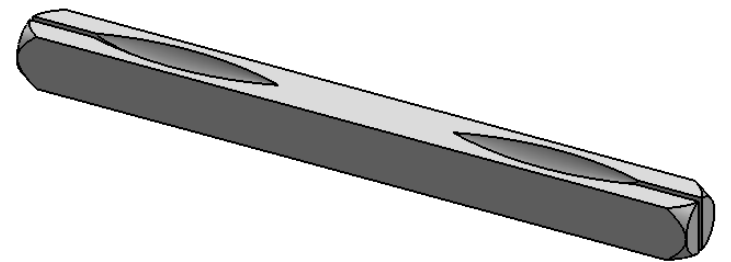
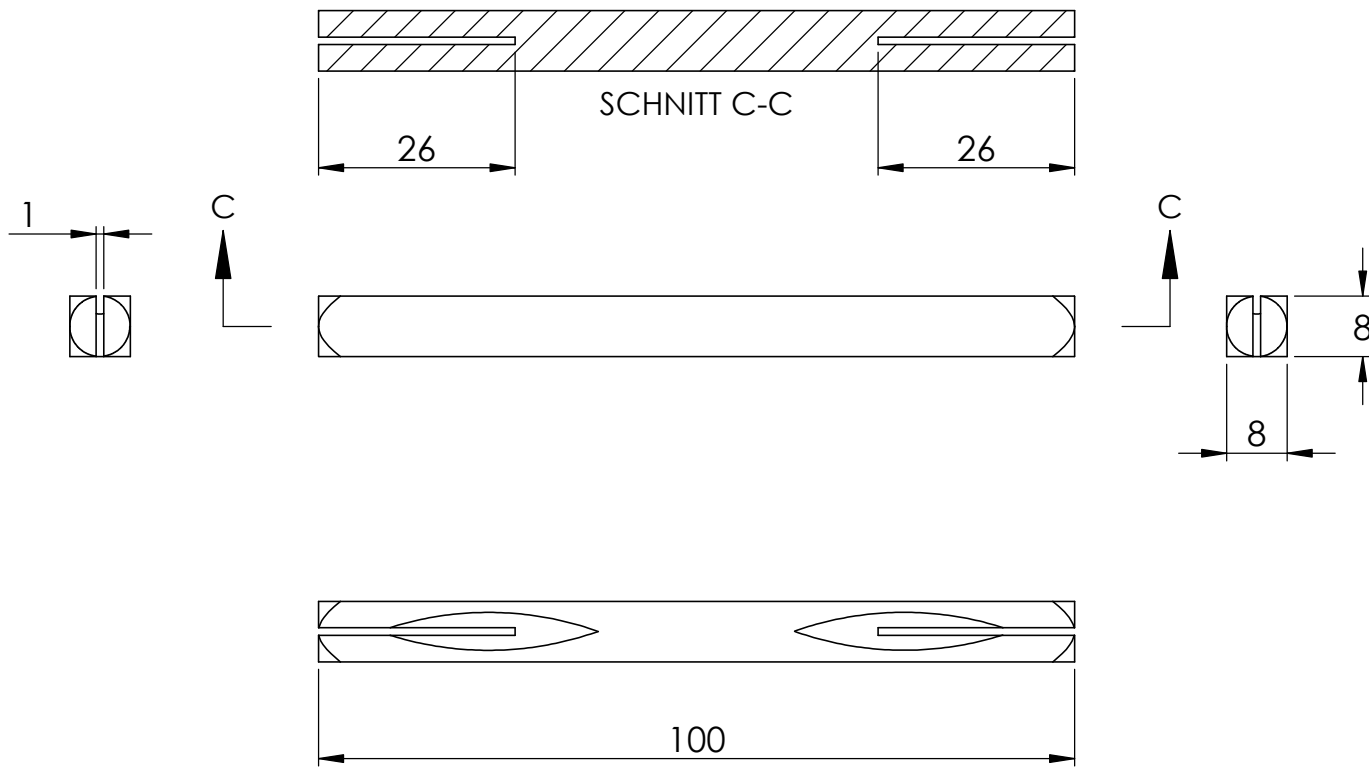

4	56652-240 Teil3	2
5	DIN 914 M6x6	2

