

SCHNITT A-A

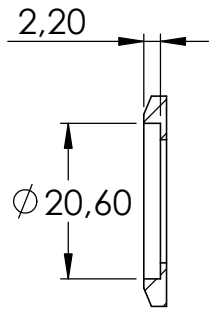

SCHNITT B-B

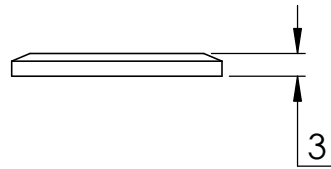
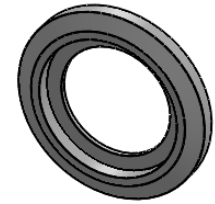
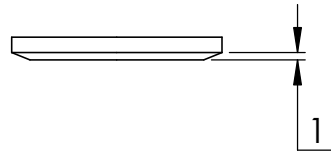
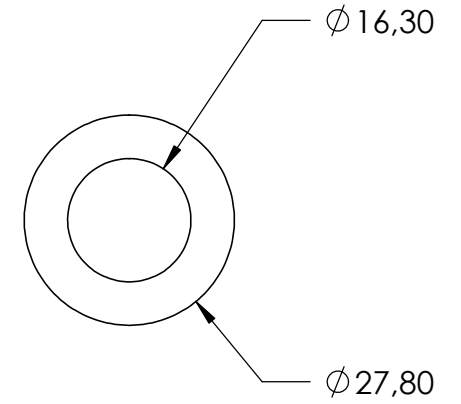
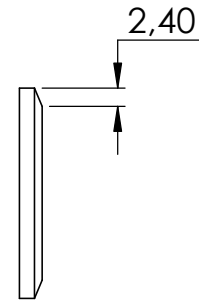
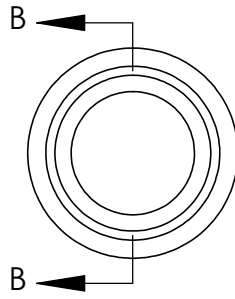

SCHNITT C-C

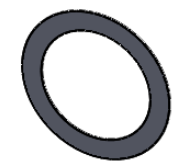
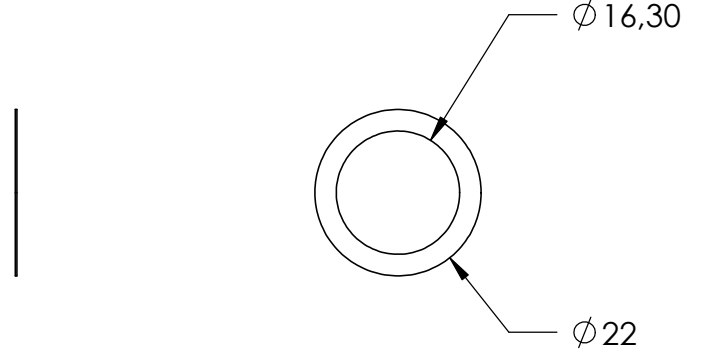
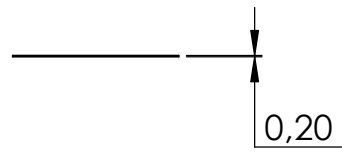
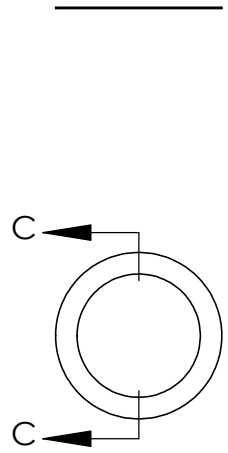

SCHNITT D-D

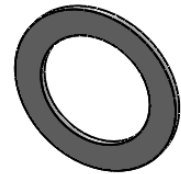
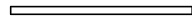
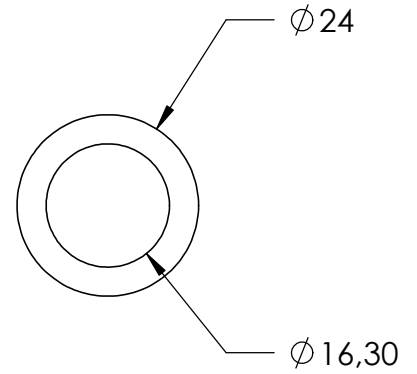
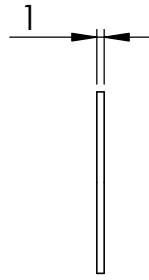
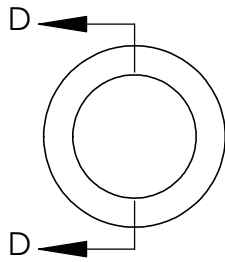

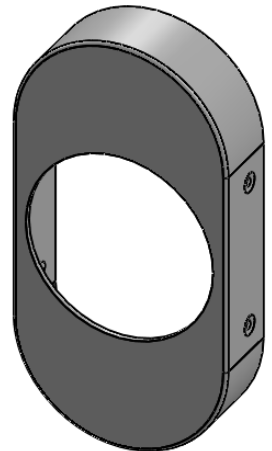
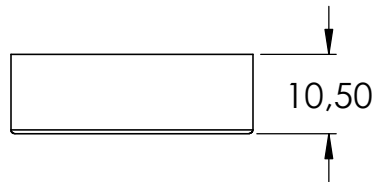
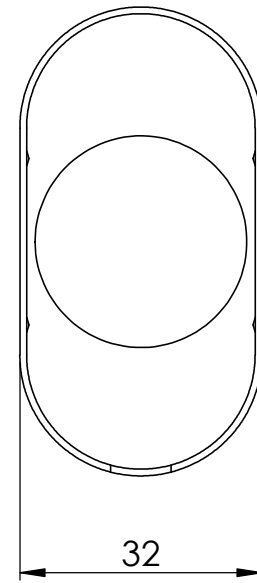
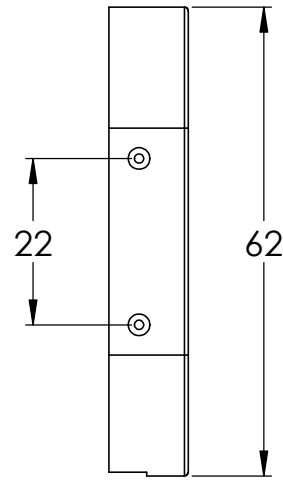
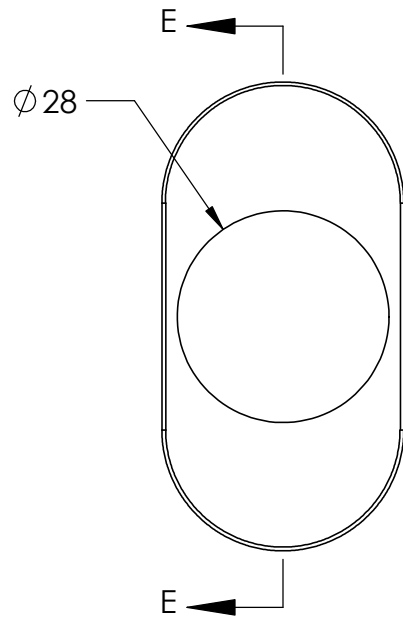
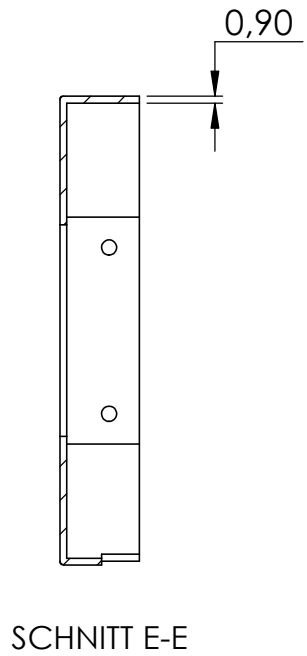
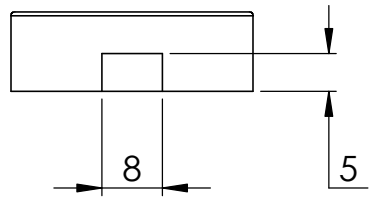

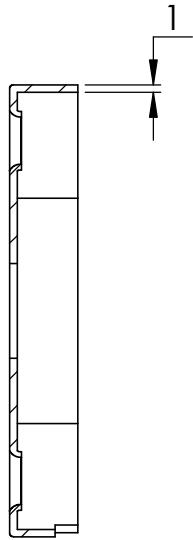
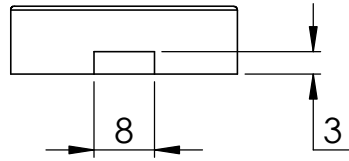

SCHNITT F-F

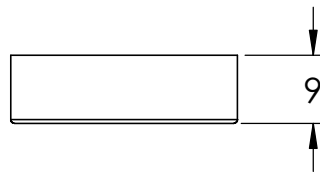
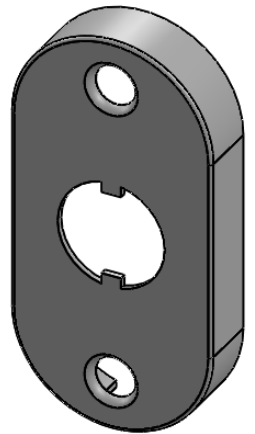
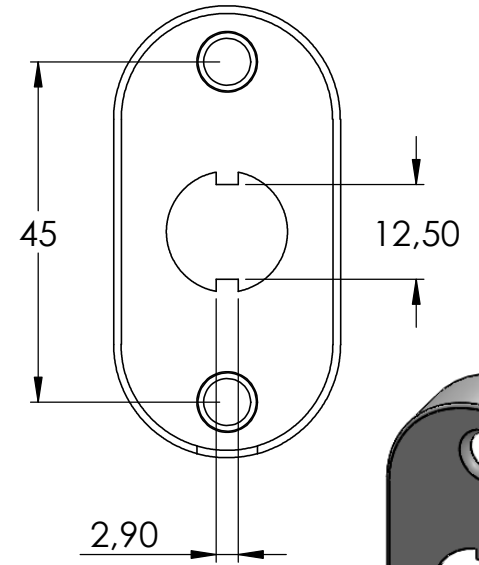
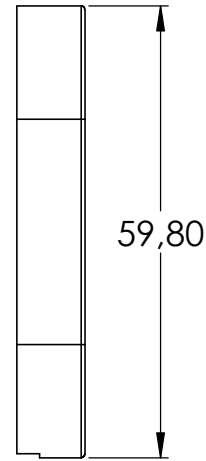
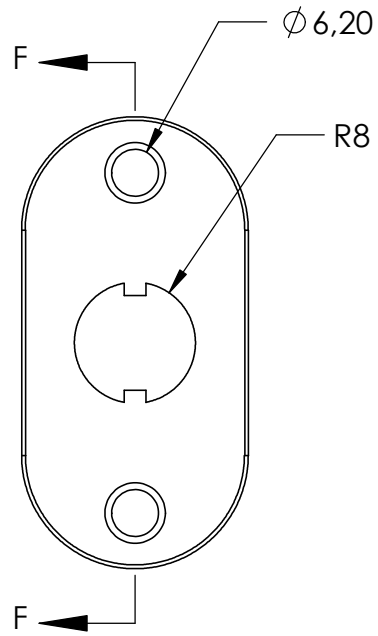

4	212-VA-F Teil2	1
5	212-VA-F Teil3	1
6	212-VA-F Teil4	1
7	212-VA-F Teil5	1
8	212-VA-F Teil1	1

