

DIN 914  
M5x8

DIN 914  
M5x5

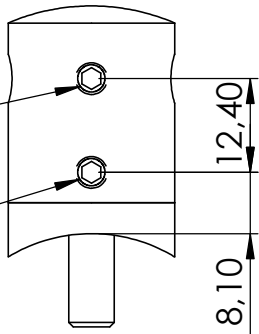

$\phi 6,50$

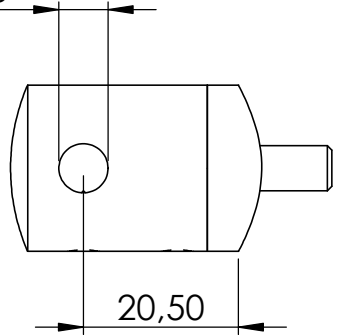

DIN 7991  
M6x25

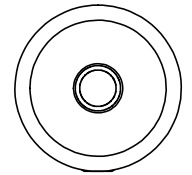
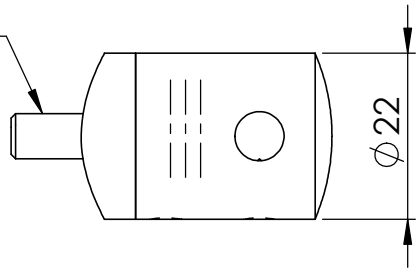

R21,20

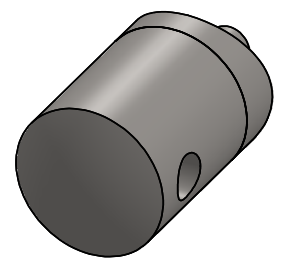
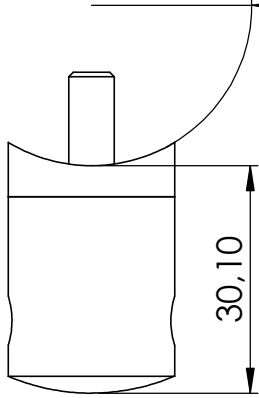

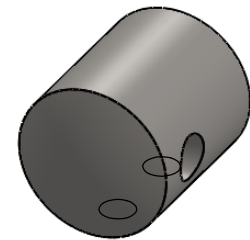
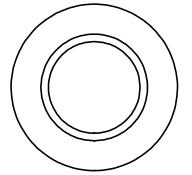
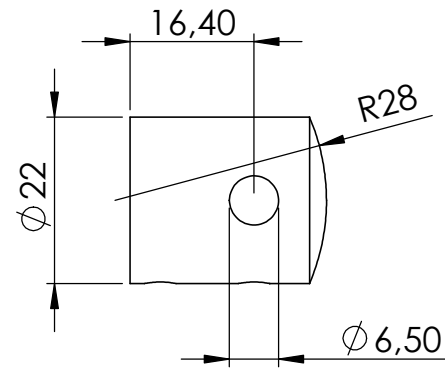
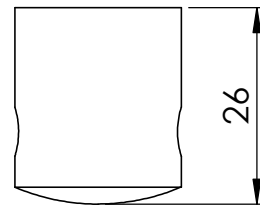
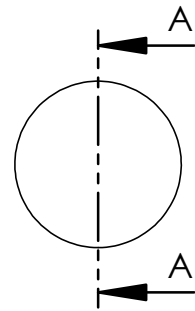
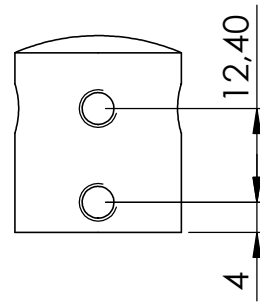
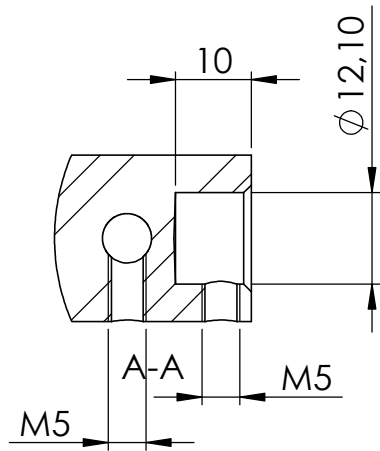

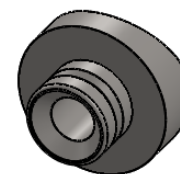
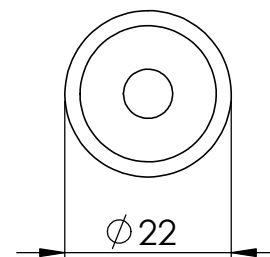
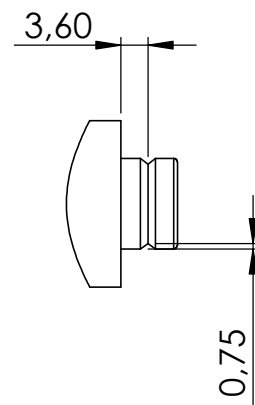
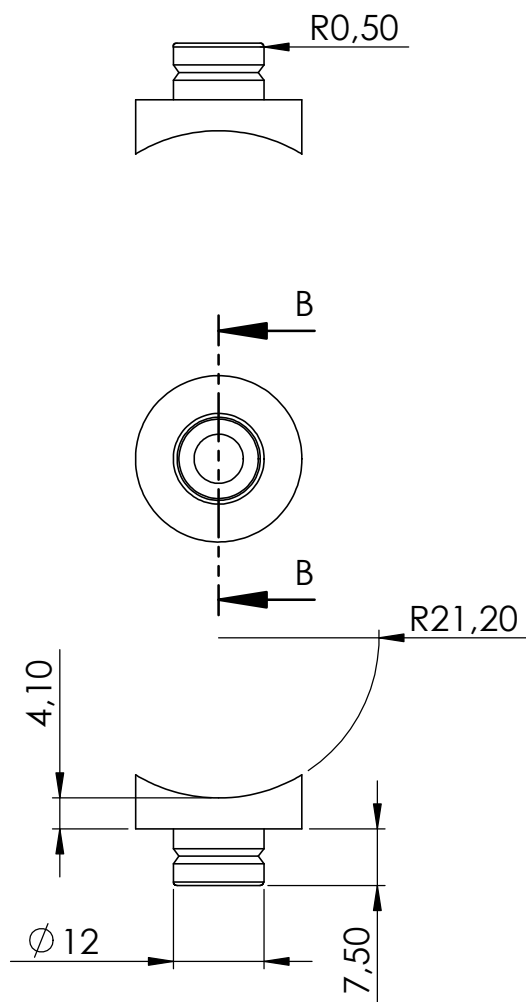
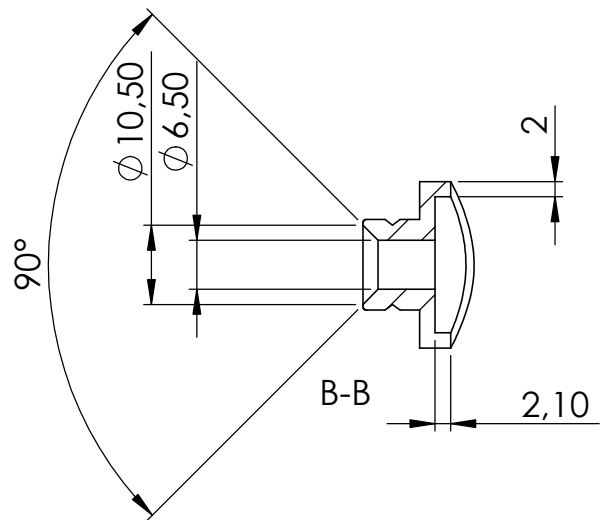

4	DIN 914 M5x5	1
5	DIN7991 M6x25	1

