

$\phi 8$

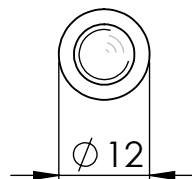
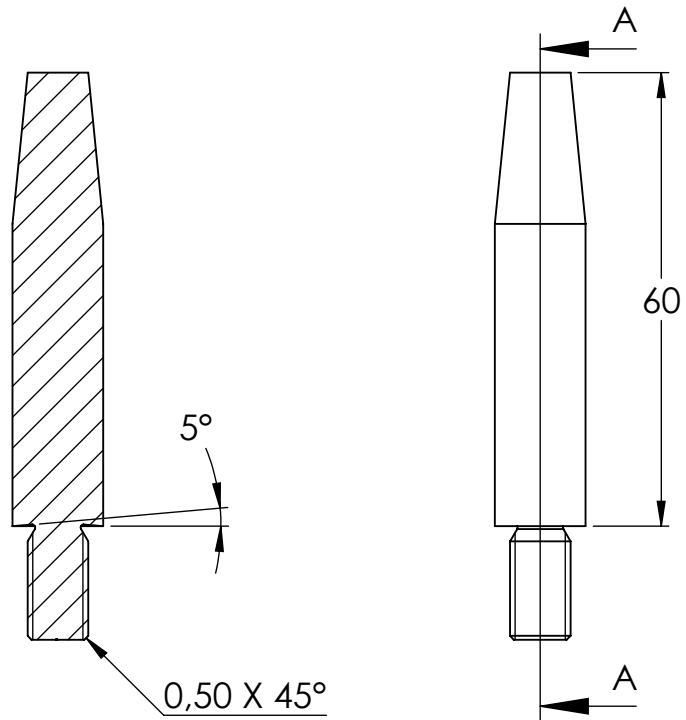

Name	Signatur	Datum	Artikelnummer	Oberfläche: Geschliffen Korn 240
Ch. Höfig	CH	14.09.2023	50217-240-60	
Werkstoff: 1.4301 (X5CrNi18-10)			Hersteller	Blattformat
				A4
Gewicht: 0.054 kg		Maßstab: 1:1	Version: 1	Deutsch
Blatt 1 von 1				