

Sicherungsstift und  
Sicherungsboden  
optional erhältlich

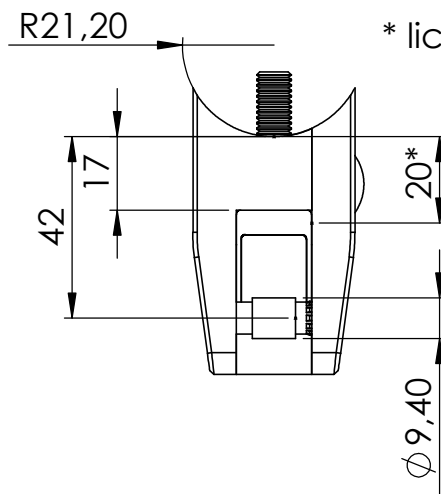

\* lichter Abstand zwischen  
Glas und Pfosten

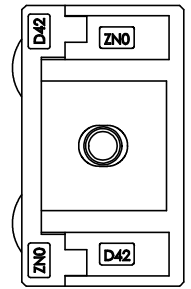

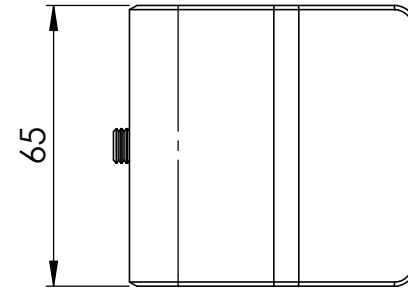
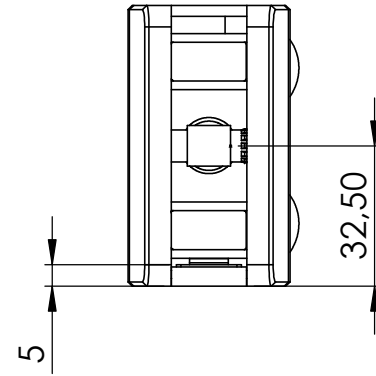
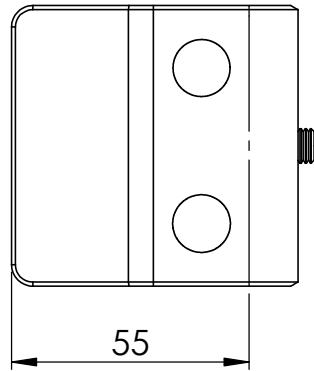
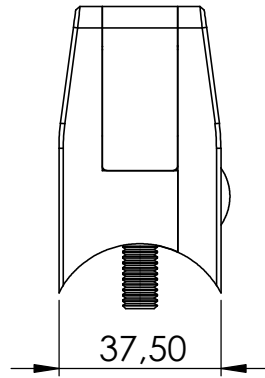
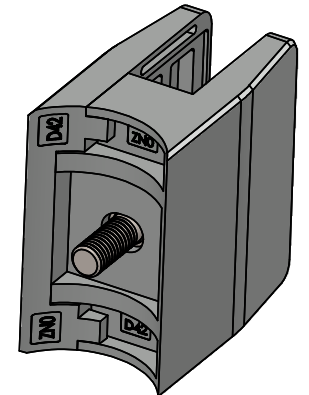
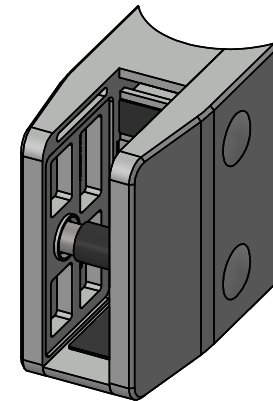
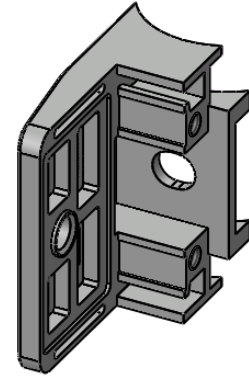
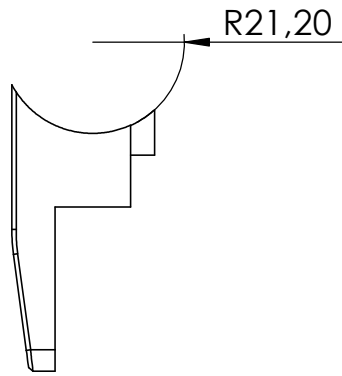
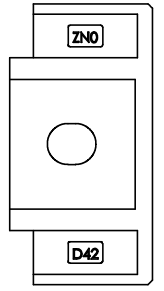
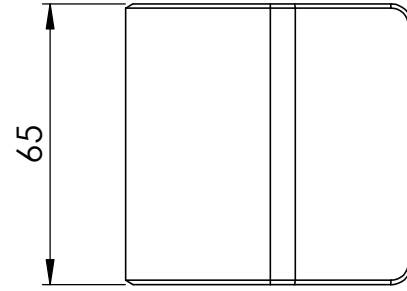
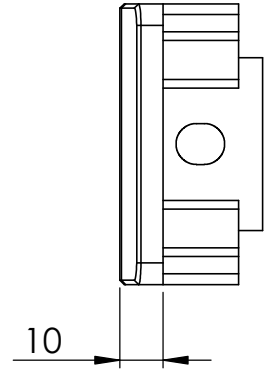
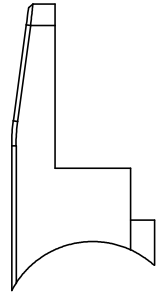
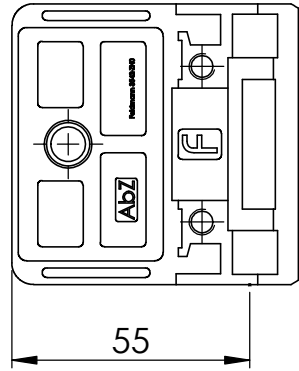

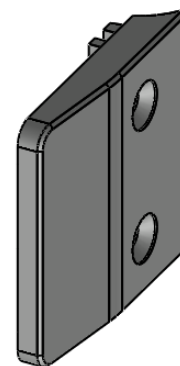
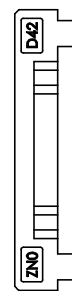
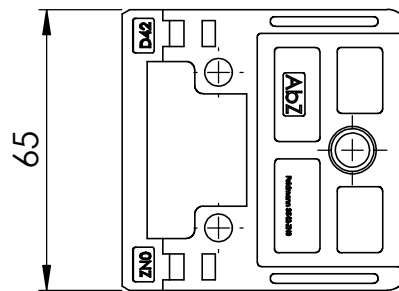
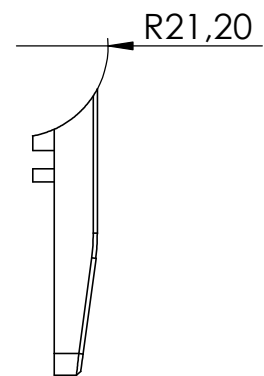
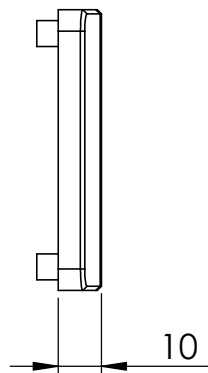
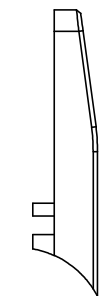
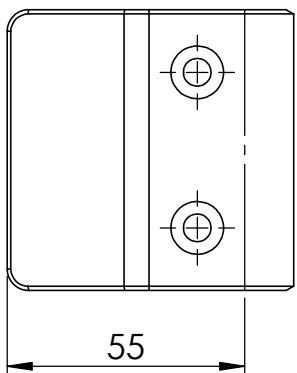

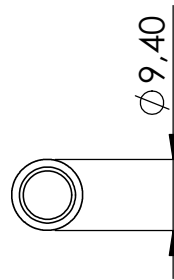
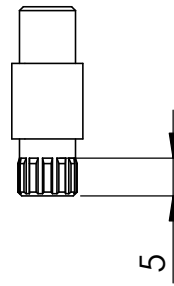
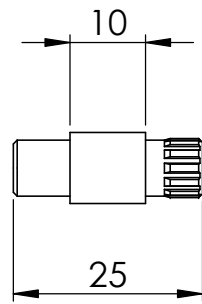

\*Sicherungsstift optional erhältlich

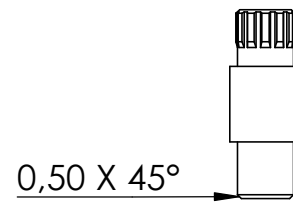
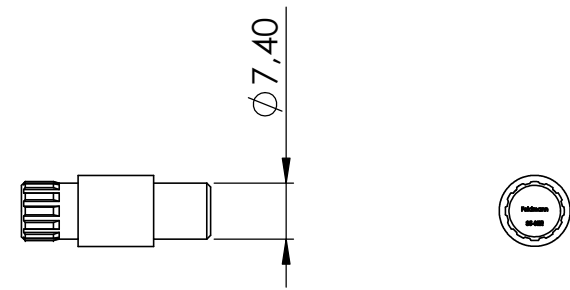

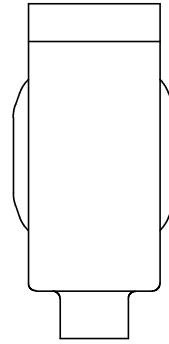

\*Sicherungsboden optional erhältlich

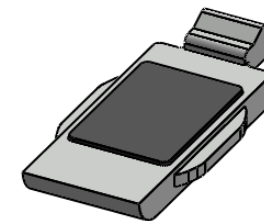
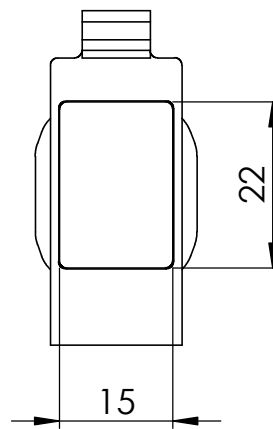
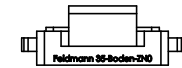
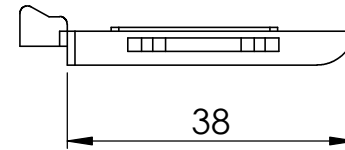
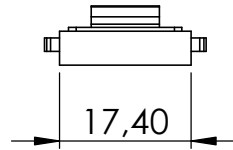
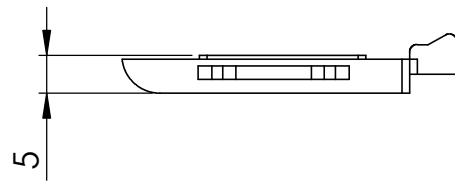

4	DIN 912 M8 x 20 --- 20S	1
5	35-Stift*	1
6	35-Kappe	2
7	Haltegummi	2
8	35-Boden-ZN0*	1

\*optional erhältlich

