

Sicherungsstift und
Sicherungsboden
optional erhältlich

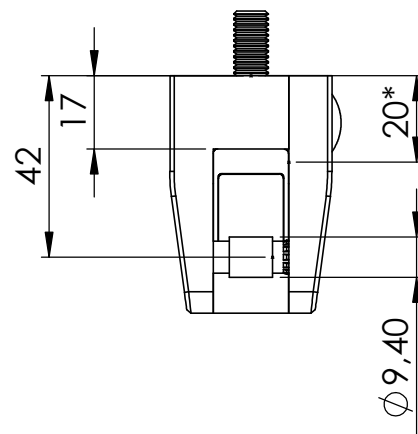

* lichter Abstand zwischen
Glas und Pfosten

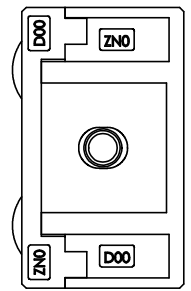

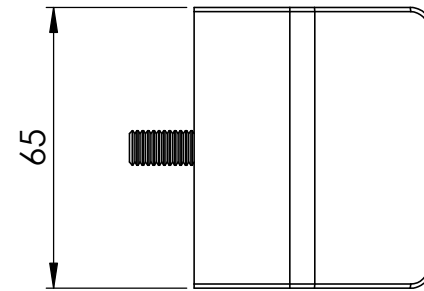
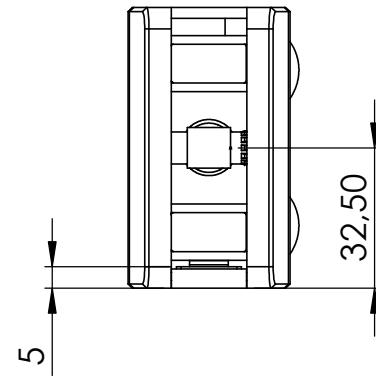
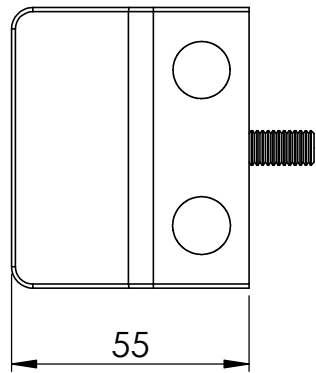
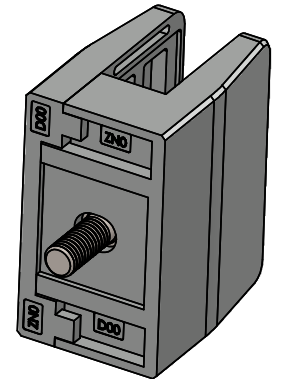
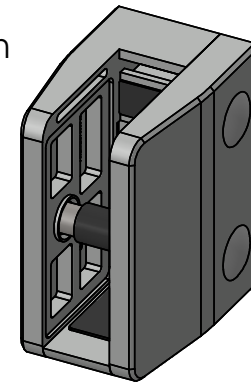
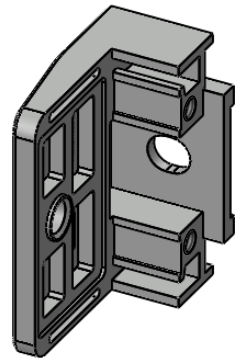
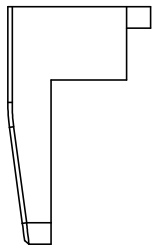
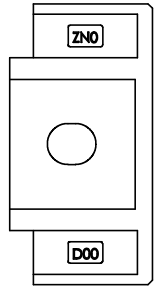
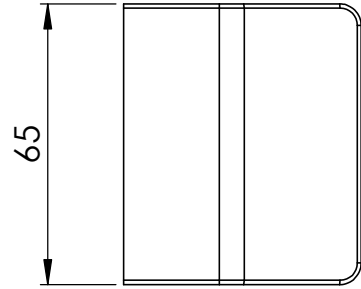
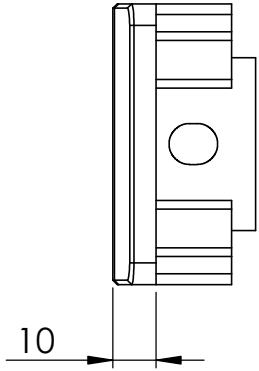
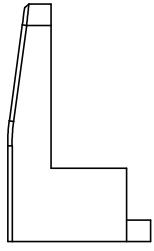
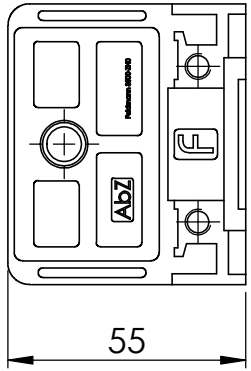

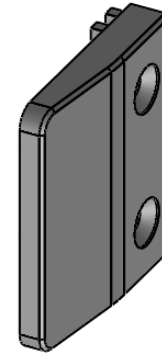
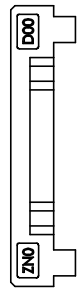
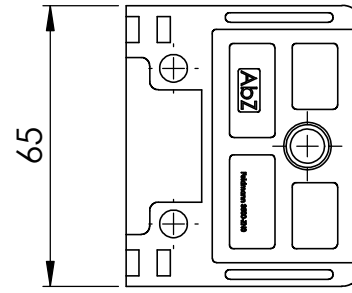
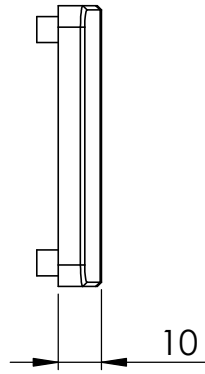
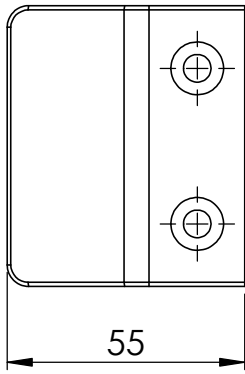

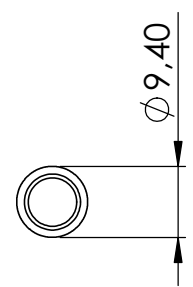
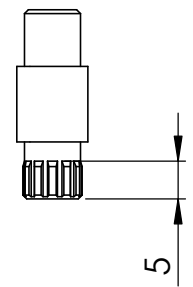
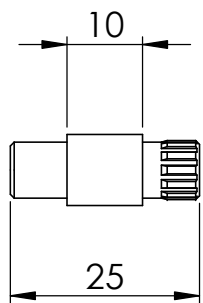

*Sicherungsstift optional erhältlich

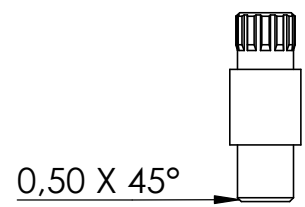
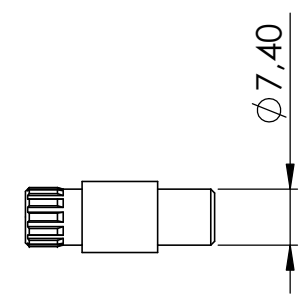

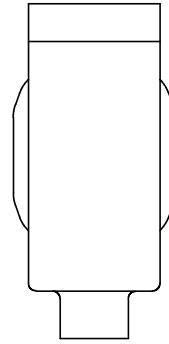

*Sicherungsboden optional erhältlich

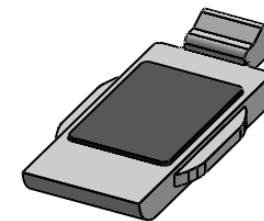
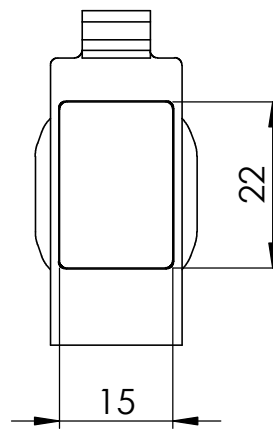
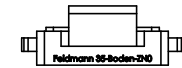
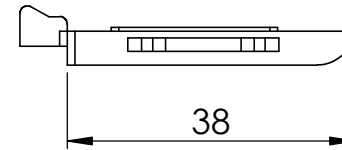
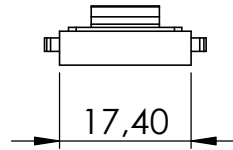
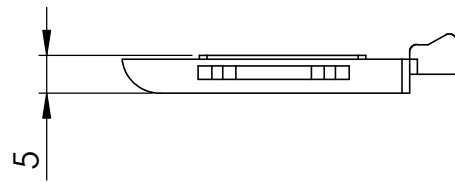

4	DIN 912 M8 x 20 --- 20S	1
5	35-Stift*	1
6	35-Kappe	2
7	Haltegummi	2
8	35-Boden-ZN0*	1

*optional erhältlich

