

Sicherungsstift und
Sicherungsboden
optional erhältlich

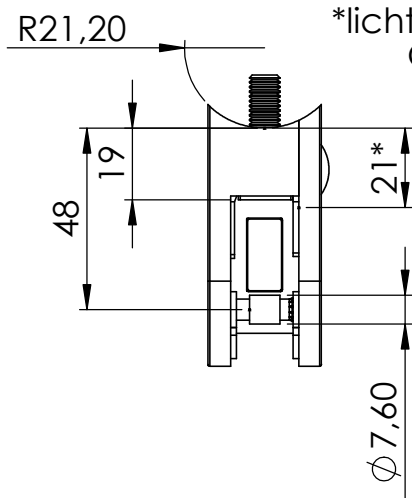

*lichter Abstand zwischen
Glas und Pfosten

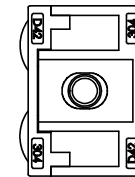

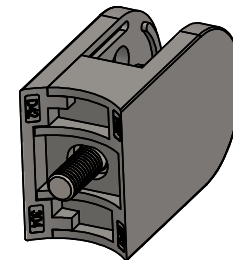
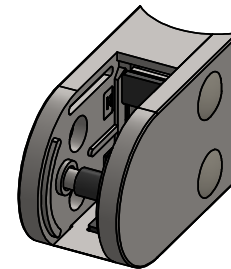
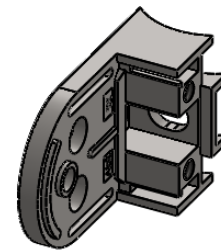
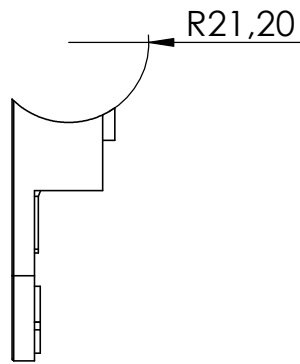
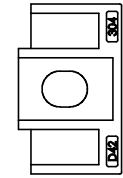
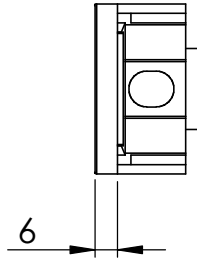
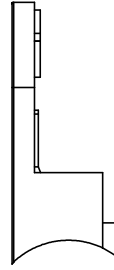
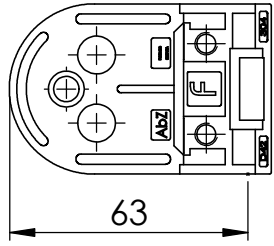

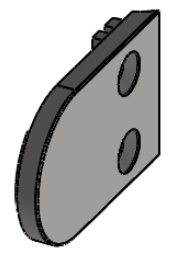
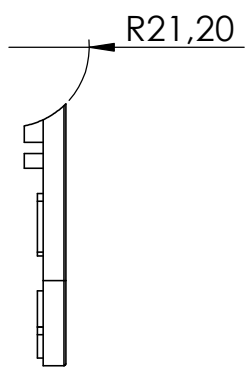
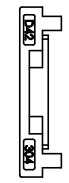
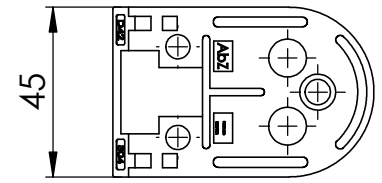
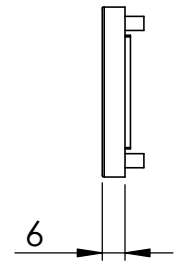
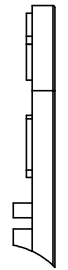
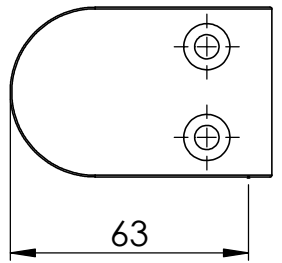

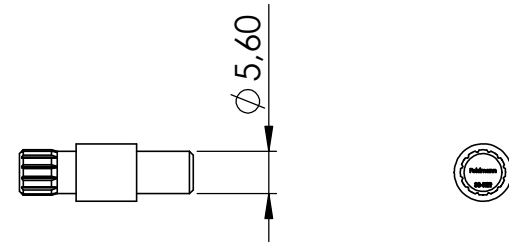
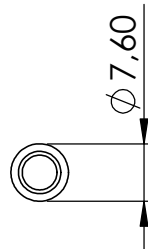
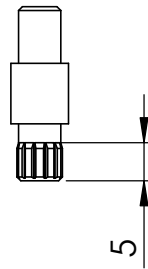
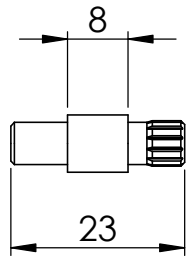

* Sicherungstift optional erhältlich

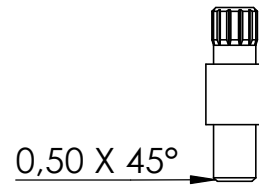

*Sicherungsboden optional erhältlich

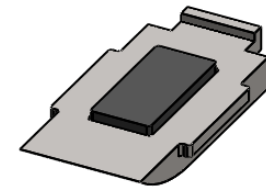
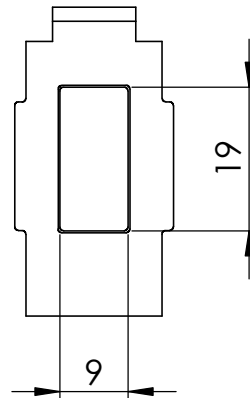
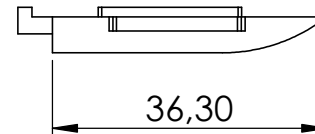
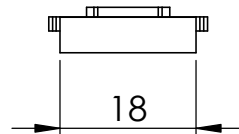
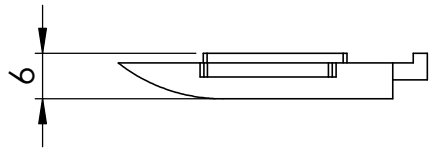
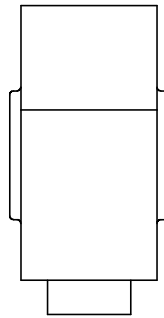

4	DIN 912 M8 x 20 --- 20S	1
5	DIN 7991 - M6 x 16 --- 16S	2
6	38-Stift*	1
7	38-Kappe	2
8	38-Boden-V2A*	1

*optional erhältlich

